

AT03T
ACTUAL







System 600

Rahmen

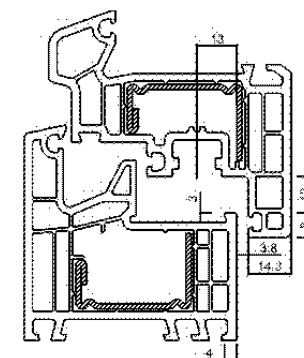
Fluegel

Falzlufthöhe mm: Ueberschlag mm: Versatz mm:



Schliessteilleisten U-Profil 												
Schloss	Silber	Tricoat	Silber	Tricoat	Silber	Tricoat	Silber	Tricoat	Silber	Tricoat	Silber	Tricoat
Fuer Z-TF	2MF + 2iS		2MF + 2iS K+500		2MF + 3iS K+1030		2MF + 4iS		2MF + 4iS K+500		2MF-BO	
rechts												
links												
Fuer Z-TF	2MF-BO K+605		2MF-BO K+980		Fuer Z-TS		2 HO-BO + ZS		4 HO-BO			
rechts					rechts							
links					links							
Fuer Z-TS	3 iS + TB		2 HO-BO + TB		4 iS		3iS + ZS		2 HO-BO		2 HO-BO + 2iS	
rechts												
links												
Fuer G-TS	4 iS		2 BO		2 BO+ZS							
rechts												
links												
Schliessteile fuer Z-TS, Z-TF, G-TS					i.S. U-Profil 			Rechts		Links		
Fallen- u Riegelschliessteile								Silber	Tricoat	Silber	Tricoat	
Ausfuehrung	U-6x24x6							- / + mm				
	Rechts		Links									
Anpressdr.	Silber	Tricoat	Silber	Tricoat								
	211168		211169									
Exenter					i.S. ZA 							
f. E-Oeffner	213858		213859									- / + mm

Schliessteile fuer Z-TF			Fallenschließteil ZT-F	MF-BO f. Z-TF				
Anpressdr.	Silber	Tricoat			Silber	Tricoat		
	211181			rechts				
Excenter				links				
f. E-Oeffner								
Schliessteile fuer Z-TS			TB-Schliessteil	Schliessteile fuer Z-TS			HO-BO ZA	
	Silber	Tricoat		Anpressdr.	Silber	Tricoat		
Rechts								
Links				- / + mm				
Schliessteile fuer Z-TS			HO-BO U	Riegelschliessteil f. 2-flg. Haustueren ZA (Z-TS, Z-TF,G-TS)				
Anpressdr.	Silber	Tricoat		Anpressdr.	Silber	Tricoat		
				- / + mm				
- / + mm								
Schliessteile fuer G-TS			Hakenschliesst. U-Profil	Schliessteile fuer G-TS			Hakenschliessteil ZA	
Anpressdr.	Silber	Tricoat		Anpressdr.	Silber	Tricoat		
				- / + mm				
- / + mm								
Schliessteile fuer G-TS			Bolzenschliesst. U-Profil	Schliessteile fuer G-TS			Bolzenschliessteil ZA	
Anpressdr.	Silber	Tricoat		Anpressdr.	Silber	Tricoat		
				- / + mm				
- / + mm								
Fraesabdeckungen f. Schließteile		Schwarz	Verarbeitungshinweise					
Bolzen			F. E-Oeffner effeff 118E.15 --- A71 Profix2					
Haken + Zusatzschloss			Schliessteil f. Falle u. Riegel silber:					
Riegelschliessteil			213858 rechts, 213859 links, Fallenschliessteil MF: 213860					
HO BO								
Fallen - u. Riegelschliessteil								

Rechtsansprüche aus der Anwendung der in diesem Profilblatt angegebenen Artikel können nicht geltend gemacht werden. Dieses Profilblatt ersetzt keine Pruefung in einem akkreditiertem Pruefinstitut !

ALL02T
ALL.CO
Wood



Rahmen					
Fluegel					
Falzlufth mm:	12	Ueberschlag mm:	18	Versatz mm:	13

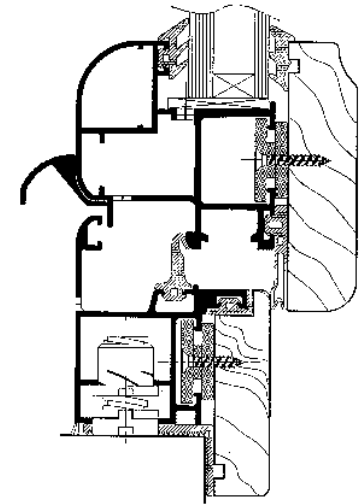

Rechtsansprüche aus der Anwendung der in diesem Profilblatt angegebenen Artikel können nicht geltend gemacht werden. Dieses Profilblatt ersetzt keine Prüfung in einem akkreditiertem Prüfinstitut !

AP02T
ALPHACAN
MD Plus_PROTECT









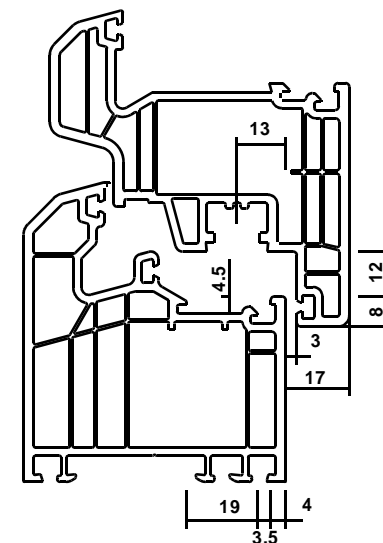





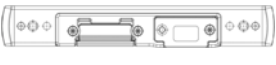

Rahmen

Fluegel

Falzlufthöhe mm: Ueberschlag mm: Versatz mm:



Schliessteilleisten U-Profil 													
Schloss	Silber	Tricoat	Silber	Tricoat	Silber	Tricoat	Silber	Tricoat	Silber	Tricoat	Silber	Tricoat	
Fuer Z-TF	2MF + 2iS		2MF + 2iS K+500		2MF + 3iS K+1030		2MF + 4iS		2MF + 4iS K+500		2MF-BO		
rechts													
links													
Fuer Z-TF	2MF-BO K+605		2MF-BO K+980		Fuer Z-TS		2 HO-BO + ZS		4 HO-BO				
rechts					rechts								
links					links								
Fuer Z-TS	3 iS + TB		2 HO-BO + TB		4 iS		3iS + ZS		2 HO-BO		2 HO-BO + 2iS		
rechts													
links													
Fuer G-TS	4 iS		2 BO		2 BO+ZS								
rechts													
links													
Schliessteile fuer Z-TS, Z-TF, G-TS					 i.S. U-Profil 		Rechts		Links				
Fallen- u Riegelschliessteile							Silber	Tricoat	Silber	Tricoat			
Ausfuehrung							- / + mm						
	Rechts		Links										
Anpressdr.	Silber	Tricoat	Silber	Tricoat									
Exenter					 i.S. ZA 								
f. E-Oeffner													

Schliessteile fuer Z-TF			Fallenschließteil ZT-F		MF-BO f. Z-TF				
Anpressdr.	Silber	Tricoat				Silber	Tricoat		
					rechts	217198			
Excenter					links	217198			
f. E-Oeffner									
Schliessteile fuer Z-TS			TB-Schliessteil		Schliessteile fuer Z-TS			HO-BO ZA	
	Silber	Tricoat			Anpressdr.	Silber	Tricoat		
Rechts						217121			
Links					- / + mm				
Schliessteile fuer Z-TS			HO-BO U		Riegelschliessteil f. 2-flg. Haustueren ZA (Z-TS, Z-TF,G-TS)				
Anpressdr.	Silber	Tricoat			Anpressdr.	Silber	Tricoat		
					- / + mm				
- / + mm									
Schliessteile fuer G-TS			Hakenschliesst. U-Profil		Schliessteile fuer G-TS			Hakenschliessteil ZA	
Anpressdr.	Silber	Tricoat			Anpressdr.	Silber	Tricoat		
					- / + mm				
- / + mm									
Schliessteile fuer G-TS			Bolzenschliesst. U-Profil		Schliessteile fuer G-TS			Bolzenschliessteil ZA	
Anpressdr.	Silber	Tricoat			Anpressdr.	Silber	Tricoat		
					- / + mm				
- / + mm									
Fraesabdeckungen f. Schließteile		Schwarz	Verarbeitungshinweise						
Bolzen									
Haken + Zusatzschloss									
Riegelschliessteil									
HO BO									
Fallen - u. Riegelschliessteil									

Rechtsansprüche aus der Anwendung der in diesem Profilblatt angegebenen Artikel können nicht geltend gemacht werden. Dieses Profilblatt ersetzt keine Pruefung in einem akkreditiertem Pruefinstitut !

AP01T
ALPHACAN



System Class_PROTECT







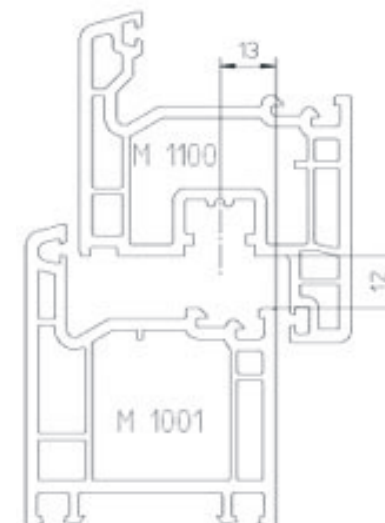

Rahmen

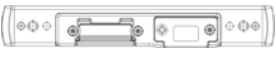
Fluegel

Falzlufthöhe mm: Ueberschlag mm: Versatz mm:

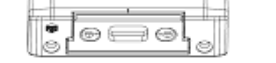

Schliessteilleisten U-Profil												
Schloss	Silber	Tricoat	Silber	Tricoat	Silber	Tricoat	Silber	Tricoat	Silber	Tricoat	Silber	Tricoat
Fuer Z-TF	2MF + 2iS		2MF + 2iS K+500		2MF + 3iS K+1030		2MF + 4iS		2MF + 4iS K+500		2MF-BO	
rechts	210911										216324	
links	210912										216325	
Fuer Z-TF	2MF-BO K+605		2MF-BO K+980		Fuer Z-TS		2 HO-BO + ZS		4 HO-BO			
rechts	216326		216328		rechts							
links	216327		216329		links							
Fuer Z-TS	3 iS + TB		2 HO-BO + TB		4 iS		3iS + ZS		2 HO-BO		2 HO-BO + 2iS	
rechts												
links												
Fuer G-TS	4 iS		2 BO		2 BO+ZS							
rechts												
links												
Schliessteile fuer Z-TS, Z-TF, G-TS					i.S. U-Profil			Rechts		Links		
Fallen- u Riegelschliessteile								Silber	Tricoat	Silber	Tricoat	
Ausfuehrung	U-6x32x6							- / + mm				
		Rechts		Links								
Anpressdr.	Silber	Tricoat	Silber	Tricoat								
	209089		209090									
Exenter	209086		209087									
f. E-Oeffner					i.S. ZA			357361		357362		
								- / + mm				

Schliessteile fuer Z-TF			Fallenschließteil ZT-F		MF-BO f. Z-TF				
Anpressdr.	Silber	Tricoat				Silber	Tricoat		
	209976				rechts	216330			
Excenter	209088				links	216331			
f. E-Oeffner									
Schliessteile fuer Z-TS			TB-Schliessteil		Schliessteile fuer Z-TS			HO-BO ZA	
	Silber	Tricoat			Anpressdr.	Silber	Tricoat		
Rechts						211547			
Links					- / + mm				
Schliessteile fuer Z-TS			HO-BO U		Riegelschliessteil f. 2-flg. Haustueren ZA (Z-TS, Z-TF,G-TS)				
Anpressdr.	Silber	Tricoat			Anpressdr.	Silber	Tricoat		
						206934			
- / + mm					- / + mm				
Schliessteile fuer G-TS			Hakenschliesst. U-Profil		Schliessteile fuer G-TS			Hakenschliessteil ZA	
Anpressdr.	Silber	Tricoat			Anpressdr.	Silber	Tricoat		
						206901			
- / + mm					- / + mm				
Schliessteile fuer G-TS			Bolzenschliesst. U-Profil		Schliessteile fuer G-TS			Bolzenschliessteil ZA	
Anpressdr.	Silber	Tricoat			Anpressdr.	Silber	Tricoat		
						206910			
- / + mm					- / + mm				
Fraesabdeckungen f. Schließteile		Schwarz	Verarbeitungshinweise						
Bolzen		355399							
Haken + Zusatzschloss		355401							
Riegelschliessteil		355403							
HO BO		358027							
Fallen - u. Riegelschliessteil									

Rechtsansprüche aus der Anwendung der in diesem Profilblatt angegebenen Artikel können nicht geltend gemacht werden. Dieses Profilblatt ersetzt keine Pruefung in einem akkreditiertem Pruefinstitut !

KM02T
ALTEST
KMG Prestige_PROTECT









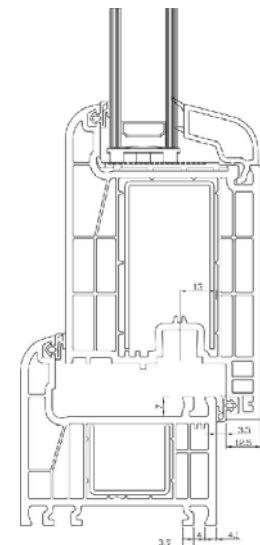



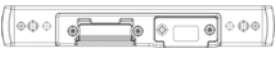
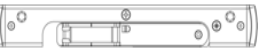

Rahmen

Fluegel

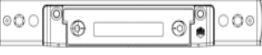
Falzluft mm: Ueberschlag mm: Versatz mm:



Schliessteilleisten U-Profil 												
Schloss	Silber	Tricoat	Silber	Tricoat	Silber	Tricoat	Silber	Tricoat	Silber	Tricoat	Silber	Tricoat
Fuer Z-TF	2MF + 2iS		2MF + 2iS K+500		2MF + 3iS K+1030		2MF + 4iS		2MF + 4iS K+500		2MF-BO	
rechts	216568		216572		216575		216581		216587		216585	
links	216570		216573		216576		216582		216588		216586	
Fuer Z-TF	2MF-BO K+605		2MF-BO K+980		Fuer Z-TS		2 HO-BO + ZS		4 HO-BO			
rechts	216589		216591		rechts							
links	216590		216592		links							
Fuer Z-TS	3 iS + TB		2 HO-BO + TB		4 iS		3iS + ZS		2 HO-BO		2 HO-BO + 2iS	
rechts					216593				216595		216597	
links					216594				216596		216598	
Fuer G-TS	4 iS		2 BO		2 BO+ZS							
rechts	216593											
links	216594											
Schliessteile fuer Z-TS, Z-TF, G-TS					i.S. U-Profil 			Rechts		Links		
Fallen- u Riegelschliessteile								Silber	Tricoat	Silber	Tricoat	
Ausfuehrung		U-6x32x9						- / + mm				
		Rechts		Links								
Anpressdr.	Silber	Tricoat	Silber	Tricoat								
	216599		216600									
Exenter					i.S. ZA 			364430		364431		
f. E-Oeffner											- / + mm	

Schliessteile fuer Z-TF			Fallenschließteil ZT-F		MF-BO f. Z-TF				
Anpressdr.	Silber	Tricoat				Silber	Tricoat		
	216601				rechts	216604			
Excenter					links	216605			
f. E-Oeffner									
Schliessteile fuer Z-TS			TB-Schliessteil		Schliessteile fuer Z-TS			HO-BO ZA	
	Silber	Tricoat			Anpressdr.	Silber	Tricoat		
Rechts						216602			
Links					- / + mm				
Schliessteile fuer Z-TS			HO-BO U		Riegelschliessteil f. 2-flg. Haustueren ZA (Z-TS, Z-TF,G-TS)				
Anpressdr.	Silber	Tricoat			Anpressdr.	Silber	Tricoat		
						216603			
- / + mm					- / + mm				
Schliessteile fuer G-TS			Hakenschliesst. U-Profil		Schliessteile fuer G-TS			Hakenschliessteil ZA	
Anpressdr.	Silber	Tricoat			Anpressdr.	Silber	Tricoat		
					- / + mm				
- / + mm									
Schliessteile fuer G-TS			Bolzenschliesst. U-Profil		Schliessteile fuer G-TS			Bolzenschliessteil ZA	
Anpressdr.	Silber	Tricoat			Anpressdr.	Silber	Tricoat		
					- / + mm				
- / + mm									
Fraesabdeckungen f. Schließteile		Schwarz	Verarbeitungshinweise						
Bolzen		355399							
Haken + Zusatzschloss		355401							
Riegelschliessteil		355403							
HO BO		358027							
Fallen - u. Riegelschliessteil									

Rechtsansprüche aus der Anwendung der in diesem Profilblatt angegebenen Artikel können nicht geltend gemacht werden. Dieses Profilblatt ersetzt keine Pruefung in einem akkreditiertem Pruefinstitut !

AL08T
ALUPLAST
Ideal 4000_PROTECT









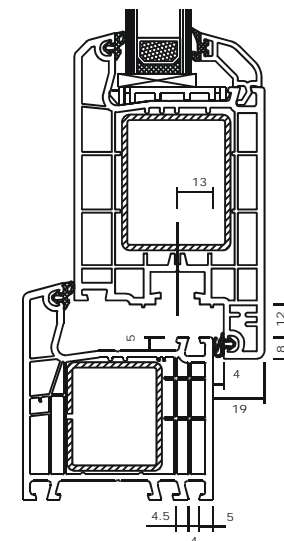

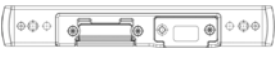

Rahmen

Fluegel

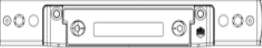
Falzluft mm: Ueberschlag mm: Versatz mm:



Schliessteilleisten U-Profil												
Schloss	Silber	Tricoat	Silber	Tricoat	Silber	Tricoat	Silber	Tricoat	Silber	Tricoat	Silber	Tricoat
Fuer Z-TF	2MF + 2iS		2MF + 2iS K+500		2MF + 3iS K+1030		2MF + 4iS		2MF + 4iS K+500		2MF-BO	
rechts	210728		212806		212808		212810		212812		215544	
links	210729		212807		212809		212811		212813		215545	
Fuer Z-TF	2MF-BO K+605		2MF-BO K+980		Fuer Z-TS		2 HO-BO + ZS		4 HO-BO			
rechts	215546		215548		rechts		215017		213656			
links	215547		215549		links		215018		213657			
Fuer Z-TS	3 iS + TB		2 HO-BO + TB		4 iS		3iS + ZS		2 HO-BO		2 HO-BO + 2iS	
rechts	212944		212946		208550		208542		211632			
links	212945		212947		208549		208541		211633			
Fuer G-TS	4 iS		2 BO		2 BO+ZS							
rechts	208550		208546		208540							
links	208549		208544		208539							
Schliessteile fuer Z-TS, Z-TF, G-TS					i.S. U-Profil 			Rechts		Links		
Fallen- u Riegelschliessteile								Silber	Tricoat	Silber	Tricoat	
Ausfuehrung	U-6x32x9							207152		207153		
	Rechts		Links						- / + mm			
Anpressdr.	Silber	Tricoat	Silber	Tricoat								
	209099		209100					354986		354999		
Exenter	209096		209097					- / + mm				
f. E-Oeffner								363389		363390		-2

Schliessteile fuer Z-TF			Fallenschließteil ZT-F		MF-BO f. Z-TF				
Anpressdr.	Silber	Tricoat				Silber	Tricoat		
	209978				rechts	215550			
Excenter	209098				links	215551			
f. E-Oeffner									
Schliessteile fuer Z-TS			TB-Schliessteil		Schliessteile fuer Z-TS			HO-BO ZA	
	Silber	Tricoat			Anpressdr.	Silber	Tricoat		
Rechts						211543			
Links					- / + mm	215071			-2
Schliessteile fuer Z-TS			HO-BO U		Riegelschliessteil f. 2-flg. Haustueren ZA (Z-TS, Z-TF,G-TS)				
Anpressdr.	Silber	Tricoat			Anpressdr.	Silber	Tricoat		
						206931			
- / + mm					- / + mm				
Schliessteile fuer G-TS			Hakenschliesst. U-Profil		Schliessteile fuer G-TS			Hakenschliessteil ZA	
Anpressdr.	Silber	Tricoat			Anpressdr.	Silber	Tricoat		
	207150					203537			
- / + mm					- / + mm				
Schliessteile fuer G-TS			Bolzenschliesst. U-Profil		Schliessteile fuer G-TS			Bolzenschliessteil ZA	
Anpressdr.	Silber	Tricoat			Anpressdr.	Silber	Tricoat		
	207151					203550			
- / + mm					- / + mm	215070			-2
Fraesabdeckungen f. Schließteile		Schwarz	Verarbeitungshinweise						
Bolzen		355399							
Haken + Zusatzschloss		355401							
Riegelschliessteil		355403							
HO BO		358027							
Fallen - u. Riegelschliessteil									





Rechtsansprüche aus der Anwendung der in diesem Profilblatt angegebenen Artikel können nicht geltend gemacht werden. Dieses Profilblatt ersetzt keine Pruefung in einem akkreditiertem Pruefinstitut !



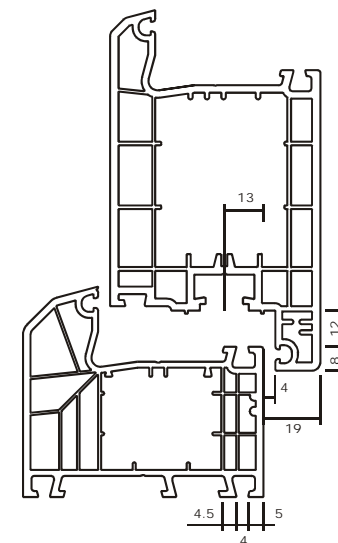





AL14T
ALUPLAST
Ideal 7000_PROTECT

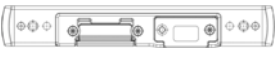
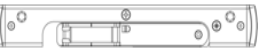

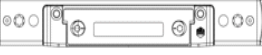
Rahmen
 Fluegel
 Falzluft mm: Ueberschlag mm: Versatz mm:



Schliessteilleisten U-Profil 												
Schloss	Silber	Tricoat	Silber	Tricoat	Silber	Tricoat	Silber	Tricoat	Silber	Tricoat	Silber	Tricoat
Fuer Z-TF	2MF + 2iS		2MF + 2iS K+500		2MF + 3iS K+1030		2MF + 4iS		2MF + 4iS K+500		2MF-BO	
rechts	210728		212806		212808		212810		212812		215544	
links	210729		212807		212809		212811		212813		215545	
Fuer Z-TF	2MF-BO K+605		2MF-BO K+980		Fuer Z-TS		2 HO-BO + ZS		4 HO-BO			
rechts	215546		215548		rechts		215017		213656			
links	215547		215549		links		215018		213657			
Fuer Z-TS	3 iS + TB		2 HO-BO + TB		4 iS		3iS + ZS		2 HO-BO		2 HO-BO + 2iS	
rechts					208550		208542		211632			
links					208549		208541		211633			
Fuer G-TS	4 iS		2 BO		2 BO+ZS							
rechts	208550		208546		208540							
links	208549		208544		208539							
Schliessteile fuer Z-TS, Z-TF, G-TS					i.S. U-Profil 			Rechts		Links		
Fallen- u Riegelschliessteile								Silber	Tricoat	Silber	Tricoat	
Ausfuehrung	U-6x32x9							207152		207153		
		Rechts		Links		- / + mm						
Anpressdr.	Silber	Tricoat	Silber	Tricoat								
	209099		209100									
Exenter	209096		209097									
f. E-Oeffner					i.S. ZA 			354986		354999		
							- / + mm					
							363389		363390		-2	

Schliessteile fuer Z-TF			Fallenschließteil ZT-F	MF-BO f. Z-TF				
Anpressdr.	Silber	Tricoat			Silber	Tricoat		
	209978			rechts	215550			
Excenter	209098			links	215551			
f. E-Oeffner								
Schliessteile fuer Z-TS			TB-Schliessteil	Schliessteile fuer Z-TS			HO-BO ZA	
	Silber	Tricoat		Anpressdr.	Silber	Tricoat		
Rechts					211543			
Links				- / + mm	215071			-2
Schliessteile fuer Z-TS			HO-BO U	Riegelschliessteil f. 2-flg. Haustueren ZA (Z-TS, Z-TF,G-TS)				
Anpressdr.	Silber	Tricoat		Anpressdr.	Silber	Tricoat		
					206931			
- / + mm				- / + mm				
Schliessteile fuer G-TS			Hakenschliesst. U-Profil	Schliessteile fuer G-TS			Hakenschliessteil ZA	
Anpressdr.	Silber	Tricoat		Anpressdr.	Silber	Tricoat		
	207150				203537			
- / + mm				- / + mm				
Schliessteile fuer G-TS			Bolzenschliesst. U-Profil	Schliessteile fuer G-TS			Bolzenschliessteil ZA	
Anpressdr.	Silber	Tricoat		Anpressdr.	Silber	Tricoat		
	207151				203550			
- / + mm				- / + mm	215070			-2
Fraesabdeckungen f. Schließteile		Schwarz	Verarbeitungshinweise					
Bolzen		355399						
Haken + Zusatzschloss		355401						
Riegelschliessteil		355403						
HO BO		358027						
Fallen - u. Riegelschliessteil								

Rechtsansprüche aus der Anwendung der in diesem Profilblatt angegebenen Artikel können nicht geltend gemacht werden. Dieses Profilblatt ersetzt keine Pruefung in einem akkreditiertem Pruefinstitut !

AL01T
ALUPLAST







Ideal 2000_PROTECT



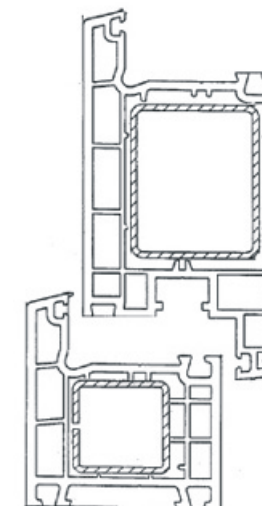



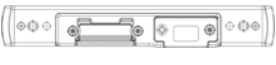

Rahmen 120002, 120003, 120004, 120042, 120043

Fluegel 120030, 120033

Falzluft mm: 12 Ueberschlag mm: 20 Versatz mm: 13

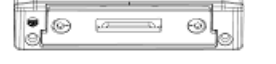

Schliessteilleisten U-Profil 												
Schloss	Silber	Tricoat	Silber	Tricoat	Silber	Tricoat	Silber	Tricoat	Silber	Tricoat	Silber	Tricoat
Fuer Z-TF	2MF + 2iS		2MF + 2iS K+500		2MF + 3iS K+1030		2MF + 4iS		2MF + 4iS K+500		2MF-BO	
rechts	210726		213700		213702		213704		213706		216928	
links	210727		213701		213703		213705		213707		216929	
Fuer Z-TF	2MF-BO K+605		2MF-BO K+980		Fuer Z-TS		2 HO-BO + ZS		4 HO-BO			
rechts	216931		216932		rechts				213654			
links			216933		links				213655			
Fuer Z-TS	3 iS + TB		2 HO-BO + TB		4 iS		3iS + ZS		2 HO-BO		2 HO-BO + 2iS	
rechts			216793		208536		208530		211630			
links			216794		208535		208529		211631			
Fuer G-TS	4 iS		2 BO		2 BO+ZS							
rechts	208536		208532		208528							
links	208535		208531		208527							
Schliessteile fuer Z-TS, Z-TF, G-TS					i.S. U-Profil 			Rechts		Links		
Fallen- u Riegelschliessteile								Silber	Tricoat	Silber	Tricoat	
Ausfuehrung	U-6x32x9				207140		207141					
		Rechts		Links		- / + mm						
Anpressdr.	Silber	Tricoat	Silber	Tricoat								
	209094		209095									
Exenter	209091		209092									
f. E-Oeffner					i.S. ZA 			355494		355506		
							- / + mm					

Schliessteile fuer Z-TF			Fallenschließteil ZT-F	MF-BO f. Z-TF				
Anpressdr.	Silber	Tricoat			Silber	Tricoat		
	209977			rechts	216926			
Excenter	209093			links	216927			
f. E-Oeffner								
Schliessteile fuer Z-TS			TB-Schliessteil	Schliessteile fuer Z-TS			HO-BO ZA	
	Silber	Tricoat		Anpressdr.	Silber	Tricoat		
Rechts	215786				211557			
Links	215787			- / + mm				
Schliessteile fuer Z-TS			HO-BO U	Riegelschliessteil f. 2-flg. Haustueren ZA (Z-TS, Z-TF,G-TS)				
Anpressdr.	Silber	Tricoat		Anpressdr.	Silber	Tricoat		
					206923			
- / + mm				- / + mm				
Schliessteile fuer G-TS			Hakenschliesst. U-Profil	Schliessteile fuer G-TS			Hakenschliessteil ZA	
Anpressdr.	Silber	Tricoat		Anpressdr.	Silber	Tricoat		
	207138				204078			
- / + mm				- / + mm				
Schliessteile fuer G-TS			Bolzenschliesst. U-Profil	Schliessteile fuer G-TS			Bolzenschliessteil ZA	
Anpressdr.	Silber	Tricoat		Anpressdr.	Silber	Tricoat		
	207139				204068			
- / + mm				- / + mm				
Fraesabdeckungen f. Schließteile		Schwarz	Verarbeitungshinweise					
Bolzen		355399						
Haken + Zusatzschloss		355401						
Riegelschliessteil		355403						
HO BO		358027						
Fallen - u. Riegelschliessteil								

Rechtsansprüche aus der Anwendung der in diesem Profilblatt angegebenen Artikel können nicht geltend gemacht werden. Dieses Profilblatt ersetzt keine Pruefung in einem akkreditiertem Pruefinstitut !

AC06T
Archicentro
Elegance 60



Rechtsansprüche aus der Anwendung der in diesem Profilblatt angegebenen Artikel können nicht geltend gemacht werden. Dieses Profilblatt ersetzt keine Prüfung in einem akkreditiertem Prüfinstitut !

BR01T

BRÜGMANN

System AD Stulp 20mm_PROTECT







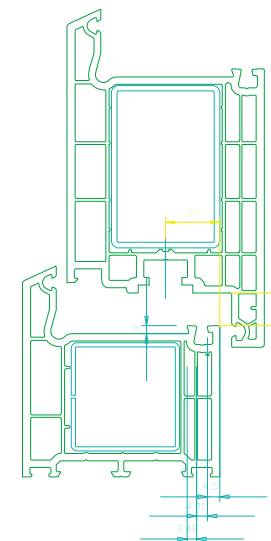

Rahmen HP103

Fluegel HP155

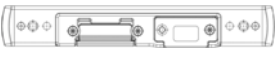
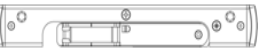
Falzlufth mm: 12 Ueberschlag mm: 20 Versatz mm: 20

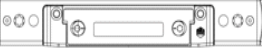

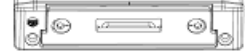
Schliessteilleisten U-Profil													
Schloss	Silber	Tricoat	Silber	Tricoat	Silber	Tricoat	Silber	Tricoat	Silber	Tricoat	Silber	Tricoat	
Fuer Z-TF	2MF + 2iS		2MF + 2iS K+500		2MF + 3iS K+1030		2MF + 4iS		2MF + 4iS K+500		2MF-BO		
rechts	214422		213694		213696		213631		213698		216947		
links	214423		213695		213697		213632		213699		216948		
Fuer Z-TF	2MF-BO K+605		2MF-BO K+980		Fuer Z-TS		2 HO-BO + ZS		4 HO-BO				
rechts	216949		216951		rechts								
links	216950		216952		links								
Fuer Z-TS	3 iS + TB		2 HO-BO + TB		4 iS		3iS + ZS		2 HO-BO		2 HO-BO + 2iS		
rechts					214424				214426				
links					214425				214427				
Fuer G-TS	4 iS		2 BO		2 BO+ZS								
rechts	214424												
links	214425												
Schliessteile fuer Z-TS, Z-TF, G-TS					i.S. U-Profil			Rechts		Links			
Fallen- u Riegelschliessteile								Silber	Tricoat	Silber	Tricoat		
Ausfuehrung	U-6x32x9				210539		210540						
		Rechts		Links		- / + mm							
Anpressdr.	Silber	Tricoat	Silber	Tricoat									
	209114		209115										
Exenter	209111		209112										
f. E-Oeffner													
					i.S. ZA			357365		357366			
								- / + mm					

Schliessteile fuer Z-TF			Fallenschließteil ZT-F		MF-BO f. Z-TF				
Anpressdr.	Silber	Tricoat				Silber	Tricoat		
	209981				rechts	216945			
Excenter	209113				links	216946			
f. E-Oeffner									
Schliessteile fuer Z-TS			TB-Schliessteil		Schliessteile fuer Z-TS			HO-BO ZA	
	Silber	Tricoat			Anpressdr.	Silber	Tricoat		
Rechts						211546			
Links					- / + mm				
Schliessteile fuer Z-TS			HO-BO U		Riegelschliessteil f. 2-flg. Haustueren ZA (Z-TS, Z-TF,G-TS)				
Anpressdr.	Silber	Tricoat			Anpressdr.	Silber	Tricoat		
						206936			
- / + mm					- / + mm				
Schliessteile fuer G-TS			Hakenschliesst. U-Profil		Schliessteile fuer G-TS			Hakenschliessteil ZA	
Anpressdr.	Silber	Tricoat			Anpressdr.	Silber	Tricoat		
	210537					206903			
- / + mm					- / + mm				
Schliessteile fuer G-TS			Bolzenschliesst. U-Profil		Schliessteile fuer G-TS			Bolzenschliessteil ZA	
Anpressdr.	Silber	Tricoat			Anpressdr.	Silber	Tricoat		
	210538					206912			
- / + mm					- / + mm				
Fraesabdeckungen f. Schließteile		Schwarz	Verarbeitungshinweise						
Bolzen		355399							
Haken + Zusatzschloss		355401							
Riegelschliessteil		355403							
HO BO		358027							
Fallen - u. Riegelschliessteil									

Rechtsansprüche aus der Anwendung der in diesem Profilblatt angegebenen Artikel können nicht geltend gemacht werden. Dieses Profilblatt ersetzt keine Pruefung in einem akkreditiertem Pruefinstitut !

BF01T
BRÜGMANN



System AD_PROTECT







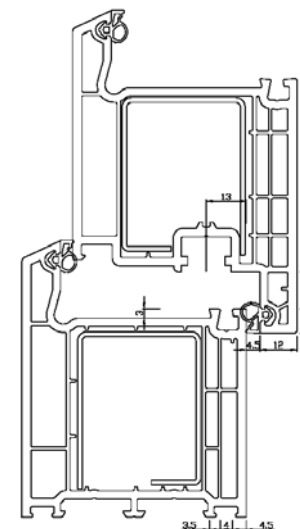

Rahmen HP1220, 1230, 1040;

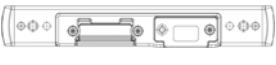
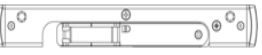
Fluegel Nebeneingangstuer HP1530 + auss HP1540

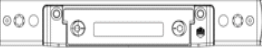
Falzlufth mm: 12 Ueberschlag mm: 20 Versatz mm: 13



Schliessteilleisten U-Profil												
Schloss	Silber	Tricoat	Silber	Tricoat	Silber	Tricoat	Silber	Tricoat	Silber	Tricoat	Silber	Tricoat
Fuer Z-TF	2MF + 2iS		2MF + 2iS K+500		2MF + 3iS K+1030		2MF + 4iS		2MF + 4iS K+500		2MF-BO	
rechts	210732		213685		213687		213629		213689		215583	
links	210733		213686		213688		213630		213690		215584	
Fuer Z-TF	2MF-BO K+605		2MF-BO K+980		Fuer Z-TS		2 HO-BO + ZS		4 HO-BO			
rechts	215585		215587		rechts				213661			
links	215586		215588		links				213662			
Fuer Z-TS	3 iS + TB		2 HO-BO + TB		4 iS		3iS + ZS		2 HO-BO		2 HO-BO + 2iS	
rechts					208586		208580		211636			
links					208585		208579		211637			
Fuer G-TS	4 iS		2 BO		2 BO+ZS							
rechts	208586		208582		208578							
links	208585		208581		208577							
Schliessteile fuer Z-TS, Z-TF, G-TS					i.S. U-Profil			Rechts		Links		
Fallen- u Riegelschliessteile								Silber		Tricoat		Silber
Ausfuehrung	U-6x32x9				207160		207161					
		Rechts		Links		- / + mm						
Anpressdr.	Silber	Tricoat	Silber	Tricoat								
	209109		209110				354988		355001			
Exenter	209106		209107				- / + mm					
f. E-Oeffner												

Schliessteile fuer Z-TF			Fallenschließteil ZT-F		MF-BO f. Z-TF				
Anpressdr.	Silber	Tricoat				Silber	Tricoat		
	209980				rechts	208601			
Excenter	209108				links	208602			
f. E-Oeffner									
Schliessteile fuer Z-TS			TB-Schliessteil		Schliessteile fuer Z-TS			HO-BO ZA	
	Silber	Tricoat			Anpressdr.	Silber	Tricoat		
Rechts						211545			
Links					- / + mm				
Schliessteile fuer Z-TS			HO-BO U		Riegelschliessteil f. 2-flg. Haustueren ZA (Z-TS, Z-TF,G-TS)				
Anpressdr.	Silber	Tricoat			Anpressdr.	Silber	Tricoat		
						206925			
- / + mm					- / + mm				
Schliessteile fuer G-TS			Hakenschliesst. U-Profil		Schliessteile fuer G-TS			Hakenschliessteil ZA	
Anpressdr.	Silber	Tricoat			Anpressdr.	Silber	Tricoat		
	207158					203539			
- / + mm					- / + mm				
Schliessteile fuer G-TS			Bolzenschliesst. U-Profil		Schliessteile fuer G-TS			Bolzenschliessteil ZA	
Anpressdr.	Silber	Tricoat			Anpressdr.	Silber	Tricoat		
	207159					203552			
- / + mm					- / + mm				
Fraesabdeckungen f. Schließteile		Schwarz	Verarbeitungshinweise						
Bolzen		355399							
Haken + Zusatzschloss		355401							
Riegelschliessteil		355403							
HO BO		358027							
Fallen - u. Riegelschliessteil									





Rechtsansprüche aus der Anwendung der in diesem Profilblatt angegebenen Artikel können nicht geltend gemacht werden. Dieses Profilblatt ersetzt keine Pruefung in einem akkreditiertem Pruefinstitut !



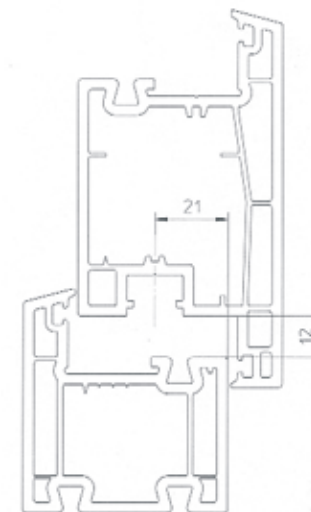



DE02T

DECEUNINCK

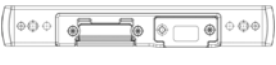
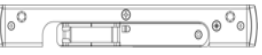
800 21mm Versatz_PROTECT

Rahmen Fluegel Falzluft mm: Ueberschlag mm: Versatz mm: 

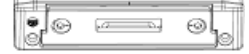
Schliessteilleisten U-Profil 												
Schloss	Silber	Tricoat	Silber	Tricoat	Silber	Tricoat	Silber	Tricoat	Silber	Tricoat	Silber	Tricoat
Fuer Z-TF	2MF + 2iS		2MF + 2iS K+500		2MF + 3iS K+1030		2MF + 4iS		2MF + 4iS K+500		2MF-BO	
rechts												
links												
Fuer Z-TF	2MF-BO K+605		2MF-BO K+980		Fuer Z-TS		2 HO-BO + ZS		4 HO-BO			
rechts					rechts							
links					links							
Fuer Z-TS	3 iS + TB		2 HO-BO + TB		4 iS		3iS + ZS		2 HO-BO		2 HO-BO + 2iS	
rechts												
links												
Fuer G-TS	4 iS		2 BO		2 BO+ZS							
rechts												
links												
Schliessteile fuer Z-TS, Z-TF, G-TS					i.S. U-Profil 			Rechts		Links		
Fallen- u Riegelschliessteile								Silber	Tricoat	Silber	Tricoat	
Ausfuehrung		U-6x32x9						- / + mm				
		Rechts		Links								
Anpressdr.	Silber	Tricoat	Silber	Tricoat								
	209119		209120									
Exenter	209116		209117									
f. E-Oeffner					i.S. ZA 			357367		357368		
								- / + mm				

Schliessteile fuer Z-TF			Fallenschließteil ZT-F	MF-BO f. Z-TF				
Anpressdr.	Silber	Tricoat			Silber	Tricoat		
	209982			rechts				
Excenter	209118			links				
f. E-Oeffner								
Schliessteile fuer Z-TS			TB-Schliessteil	Schliessteile fuer Z-TS			HO-BO ZA	
	Silber	Tricoat		Anpressdr.	Silber	Tricoat		
Rechts					211548			
Links				- / + mm				
Schliessteile fuer Z-TS			HO-BO U	Riegelschliessteil f. 2-flg. Haustueren ZA (Z-TS, Z-TF,G-TS)				
Anpressdr.	Silber	Tricoat		Anpressdr.	Silber	Tricoat		
					206937			
- / + mm				- / + mm				
Schliessteile fuer G-TS			Hakenschliesst. U-Profil	Schliessteile fuer G-TS			Hakenschliessteil ZA	
Anpressdr.	Silber	Tricoat		Anpressdr.	Silber	Tricoat		
					206904			
- / + mm				- / + mm				
Schliessteile fuer G-TS			Bolzenschliesst. U-Profil	Schliessteile fuer G-TS			Bolzenschliessteil ZA	
Anpressdr.	Silber	Tricoat		Anpressdr.	Silber	Tricoat		
					206913			
- / + mm				- / + mm				
Fraesabdeckungen f. Schließteile		Schwarz	Verarbeitungshinweise					
Bolzen		355399						
Haken + Zusatzschloss		355401						
Riegelschliessteil		355403						
HO BO		358027						
Fallen - u. Riegelschliessteil								

Rechtsansprüche aus der Anwendung der in diesem Profilblatt angegebenen Artikel können nicht geltend gemacht werden. Dieses Profilblatt ersetzt keine Pruefung in einem akkreditiertem Pruefinstitut !

DE10T
 DECEUNINCK
 System 2500









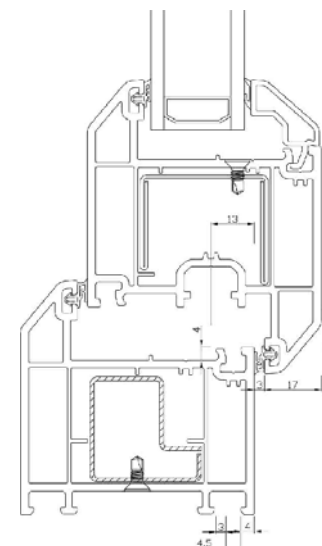



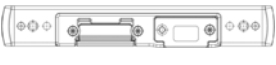

Rahmen

Fluegel

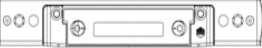
Falzlufth mm: Ueberschlag mm: Versatz mm:



Schliessteilleisten U-Profil 												
Schloss	Silber	Tricoat	Silber	Tricoat	Silber	Tricoat	Silber	Tricoat	Silber	Tricoat	Silber	Tricoat
Fuer Z-TF	2MF + 2iS		2MF + 2iS K+500		2MF + 3iS K+1030		2MF + 4iS		2MF + 4iS K+500		2MF-BO	
rechts												
links												
Fuer Z-TF	2MF-BO K+605		2MF-BO K+980		Fuer Z-TS		2 HO-BO + ZS		4 HO-BO			
rechts					rechts							
links					links							
Fuer Z-TS	3 iS + TB		2 HO-BO + TB		4 iS		3iS + ZS		2 HO-BO		2 HO-BO + 2iS	
rechts												
links												
Fuer G-TS	4 iS		2 BO		2 BO+ZS							
rechts												
links												
Schliessteile fuer Z-TS, Z-TF, G-TS					i.S. U-Profil 			Rechts		Links		
Fallen- u Riegelschliessteile								Silber	Tricoat	Silber	Tricoat	
Ausfuehrung								- / + mm				
		Rechts		Links								
Anpressdr.	Silber	Tricoat	Silber	Tricoat								
					i.S. ZA 							
Exenter								- / + mm				
f. E-Oeffner												

Schliessteile fuer Z-TF			Fallenschließteil ZT-F	MF-BO f. Z-TF					
Anpressdr.	Silber	Tricoat			Silber	Tricoat			
				rechts					
Excenter				links					
f. E-Oeffner									
Schliessteile fuer Z-TS			TB-Schliessteil	Schliessteile fuer Z-TS			HO-BO ZA		
	Silber	Tricoat		Anpressdr.	Silber	Tricoat			
Rechts									
Links				- / + mm					
Schliessteile fuer Z-TS			HO-BO U	Riegelschliessteil f. 2-flg. Haustueren ZA (Z-TS, Z-TF,G-TS)					
Anpressdr.	Silber	Tricoat		Anpressdr.	Silber	Tricoat			
				- / + mm					
- / + mm									
Schliessteile fuer G-TS			Hakenschliesst. U-Profil	Schliessteile fuer G-TS			Hakenschliessteil ZA		
Anpressdr.	Silber	Tricoat		Anpressdr.	Silber	Tricoat			
				- / + mm					
- / + mm									
Schliessteile fuer G-TS			Bolzenschliesst. U-Profil	Schliessteile fuer G-TS			Bolzenschliessteil ZA		
Anpressdr.	Silber	Tricoat		Anpressdr.	Silber	Tricoat			
				- / + mm					
- / + mm									
Fraesabdeckungen f. Schließteile		Schwarz	Verarbeitungshinweise						
Bolzen									
Haken + Zusatzschloss									
Riegelschliessteil									
HO BO									
Fallen - u. Riegelschliessteil									

Rechtsansprüche aus der Anwendung der in diesem Profilblatt angegebenen Artikel können nicht geltend gemacht werden. Dieses Profilblatt ersetzt keine Pruefung in einem akkreditiertem Pruefinstitut !

DE09T
DECEUNINCK
Zendow (3000)_PROTECT









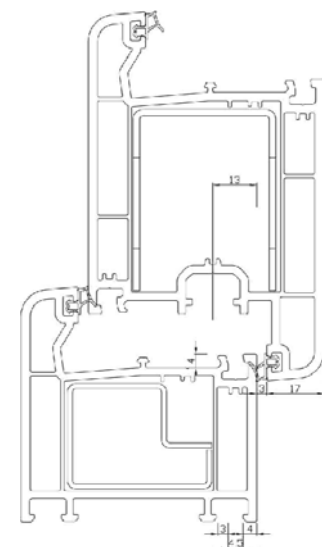



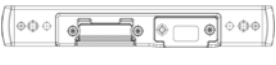

Rahmen

Fluegel

Falzlufthöhe mm: Ueberschlag mm: Versatz mm:

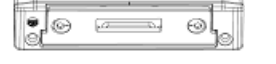

Schliessteilleisten U-Profil 												
Schloss	Silber	Tricoat	Silber	Tricoat	Silber	Tricoat	Silber	Tricoat	Silber	Tricoat	Silber	Tricoat
Fuer Z-TF	2MF + 2iS		2MF + 2iS K+500		2MF + 3iS K+1030		2MF + 4iS		2MF + 4iS K+500		2MF-BO	
rechts	210913		213400		213402		213404		213406		216053	
links	210914		213401		213403		213405		213407		216054	
Fuer Z-TF	2MF-BO K+605		2MF-BO K+980		Fuer Z-TS		2 HO-BO + ZS		4 HO-BO			
rechts	216055		216057		rechts				213663			
links	216056		216058		links				213664			
Fuer Z-TS	3 iS + TB		2 HO-BO + TB		4 iS		3iS + ZS		2 HO-BO		2 HO-BO + 2iS	
rechts					208485		208479		208473			
links					208484		208478		208472			
Fuer G-TS	4 iS		2 BO		2 BO+ZS							
rechts	208485		208481		208477							
links	208484		208480		208476							
Schliessteile fuer Z-TS, Z-TF, G-TS					i.S. U-Profil 			Rechts		Links		
Fallen- u Riegelschliessteile								Silber	Tricoat	Silber	Tricoat	
Ausfuehrung	U-6x32x6							210905		210906		
	Rechts		Links						- / + mm			
Anpressdr.	Silber	Tricoat	Silber	Tricoat								
	209124		209125					357363		357364		
Exenter	209121		209122								- / + mm	
f. E-Oeffner												

Schliessteile fuer Z-TF			Fallenschließteil ZT-F	MF-BO f. Z-TF				
Anpressdr.	Silber	Tricoat			Silber	Tricoat		
	209983			rechts	216053			
Excenter	209123			links	216054			
f. E-Oeffner								
Schliessteile fuer Z-TS			TB-Schliessteil	Schliessteile fuer Z-TS			HO-BO ZA	
	Silber	Tricoat		Anpressdr.	Silber	Tricoat		
Rechts					211549			
Links				- / + mm	217615			-2
Schliessteile fuer Z-TS			HO-BO U	Riegelschliessteil f. 2-flg. Haustueren ZA (Z-TS, Z-TF,G-TS)				
Anpressdr.	Silber	Tricoat		Anpressdr.	Silber	Tricoat		
					206935			
- / + mm				- / + mm				
Schliessteile fuer G-TS			Hakenschliesst. U-Profil	Schliessteile fuer G-TS			Hakenschliessteil ZA	
Anpressdr.	Silber	Tricoat		Anpressdr.	Silber	Tricoat		
	211626				206902			
- / + mm				- / + mm				
Schliessteile fuer G-TS			Bolzenschliesst. U-Profil	Schliessteile fuer G-TS			Bolzenschliessteil ZA	
Anpressdr.	Silber	Tricoat		Anpressdr.	Silber	Tricoat		
	211627				206911			
- / + mm				- / + mm				
Fraesabdeckungen f. Schließteile		Schwarz	Verarbeitungshinweise					
Bolzen		355399						
Haken + Zusatzschloss		355401						
Riegelschliessteil		355403						
HO BO		358027						
Fallen - u. Riegelschliessteil								





Rechtsansprüche aus der Anwendung der in diesem Profilblatt angegebenen Artikel können nicht geltend gemacht werden. Dieses Profilblatt ersetzt keine Pruefung in einem akkreditiertem Pruefinstitut !



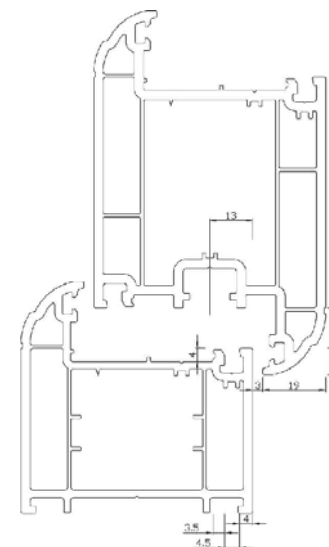



DE06T
DECEUNINCK DEEPLAS
New System 2800 70mm

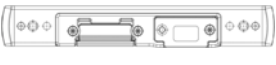
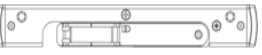

Rahmen
 Fluegel
 Falzluft mm: Ueberschlag mm: Versatz mm:

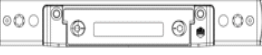

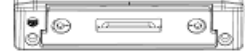
Schliessteilleisten U-Profil 												
Schloss	Silber	Tricoat	Silber	Tricoat	Silber	Tricoat	Silber	Tricoat	Silber	Tricoat	Silber	Tricoat
Fuer Z-TF	2MF + 2iS		2MF + 2iS K+500		2MF + 3iS K+1030		2MF + 4iS		2MF + 4iS K+500		2MF-BO	
rechts												
links												
Fuer Z-TF	2MF-BO K+605		2MF-BO K+980		Fuer Z-TS		2 HO-BO + ZS		4 HO-BO			
rechts					rechts							
links					links							
Fuer Z-TS	3 iS + TB		2 HO-BO + TB		4 iS		3iS + ZS		2 HO-BO		2 HO-BO + 2iS	
rechts												
links												
Fuer G-TS	4 iS		2 BO		2 BO+ZS							
rechts												
links												
Schliessteile fuer Z-TS, Z-TF, G-TS					i.S. U-Profil 			Rechts		Links		
Fallen- u Riegelschliessteile								Silber	Tricoat	Silber	Tricoat	
Ausfuehrung		U-6x32x6						- / + mm				
		Rechts		Links								
Anpressdr.	Silber	Tricoat	Silber	Tricoat								
	211061		211062									
Exenter												
f. E-Oeffner												
					i.S. ZA 			- / + mm				

Schliessteile fuer Z-TF			Fallenschließteil ZT-F	MF-BO f. Z-TF				
Anpressdr.	Silber	Tricoat			Silber	Tricoat		
				rechts				
Excenter				links				
f. E-Oeffner								
Schliessteile fuer Z-TS			TB-Schliessteil	Schliessteile fuer Z-TS			HO-BO ZA	
	Silber	Tricoat		Anpressdr.	Silber	Tricoat		
Rechts								
Links				- / + mm				
Schliessteile fuer Z-TS			HO-BO U	Riegelschliessteil f. 2-flg. Haustueren ZA (Z-TS, Z-TF,G-TS)				
Anpressdr.	Silber	Tricoat		Anpressdr.	Silber	Tricoat		
- / + mm				- / + mm				
Schliessteile fuer G-TS			Hakenschliesst. U-Profil	Schliessteile fuer G-TS			Hakenschliessteil ZA	
Anpressdr.	Silber	Tricoat		Anpressdr.	Silber	Tricoat		
- / + mm				- / + mm				
Schliessteile fuer G-TS			Bolzenschliesst. U-Profil	Schliessteile fuer G-TS			Bolzenschliessteil ZA	
Anpressdr.	Silber	Tricoat		Anpressdr.	Silber	Tricoat		
- / + mm				- / + mm				
Fraesabdeckungen f. Schließteile		Schwarz	Verarbeitungshinweise					
Bolzen								
Haken + Zusatzschloss								
Riegelschliessteil								
HO BO								
Fallen - u. Riegelschliessteil								

Rechtsansprüche aus der Anwendung der in diesem Profilblatt angegebenen Artikel können nicht geltend gemacht werden. Dieses Profilblatt ersetzt keine Pruefung in einem akkreditiertem Pruefinstitut !

DI01T
DIMEX



System Komfort_PROTECT







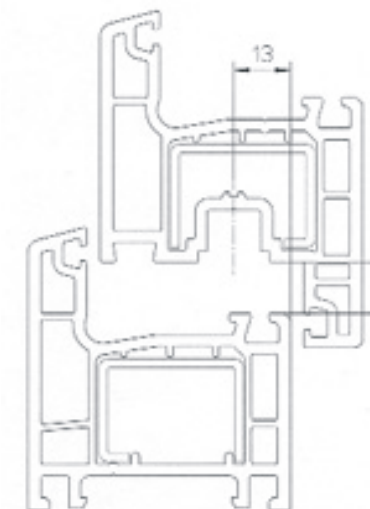

Rahmen 210100, 210500, 210400

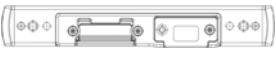
Fluegel 210200, 210300, 210600

Falzlufth mm: 12 Ueberschlag mm: 20 Versatz mm: 13

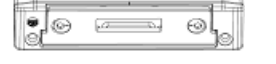

Schliessteilleisten U-Profil												
Schloss	Silber	Tricoat	Silber	Tricoat	Silber	Tricoat	Silber	Tricoat	Silber	Tricoat	Silber	Tricoat
Fuer Z-TF	2MF + 2iS		2MF + 2iS K+500		2MF + 3iS K+1030		2MF + 4iS		2MF + 4iS K+500		2MF-BO	
rechts	210728		212806		212808		212810		212812			
links	210729		212807		212809		212811		212813			
Fuer Z-TF	2MF-BO K+605		2MF-BO K+980		Fuer Z-TS		2 HO-BO + ZS		4 HO-BO			
rechts					rechts		215017		213656			
links					links		215018		213657			
Fuer Z-TS	3 iS + TB		2 HO-BO + TB		4 iS		3iS + ZS		2 HO-BO		2 HO-BO + 2iS	
rechts					208550		208542					
links					208549		208541					
Fuer G-TS	4 iS		2 BO		2 BO+ZS							
rechts	208550		208546		208540							
links	208549		208544		208539							
Schliessteile fuer Z-TS, Z-TF, G-TS					i.S. U-Profil			Rechts		Links		
Fallen- u Riegelschliessteile								Silber	Tricoat	Silber	Tricoat	
Ausfuehrung	U-6x32x9							207152		207153		
		Rechts		Links		- / + mm						
Anpressdr.	Silber	Tricoat	Silber	Tricoat								
	209099		209100									
Exenter	209096		209097									
f. E-Oeffner					i.S. ZA			354986		354999		
						- / + mm						

Schliessteile fuer Z-TF			Fallenschließteil ZT-F	MF-BO f. Z-TF				
Anpressdr.	Silber	Tricoat			Silber	Tricoat		
	209978			rechts				
Excenter	209098			links				
f. E-Oeffner								
Schliessteile fuer Z-TS			TB-Schliessteil	Schliessteile fuer Z-TS			HO-BO ZA	
	Silber	Tricoat		Anpressdr.	Silber	Tricoat		
Rechts								
Links				- / + mm				
Schliessteile fuer Z-TS			HO-BO U	Riegelschliessteil f. 2-flg. Haustueren ZA (Z-TS, Z-TF,G-TS)				
Anpressdr.	Silber	Tricoat		Anpressdr.	Silber	Tricoat		
					206931			
- / + mm				- / + mm				
Schliessteile fuer G-TS			Hakenschliesst. U-Profil	Schliessteile fuer G-TS			Hakenschliessteil ZA	
Anpressdr.	Silber	Tricoat		Anpressdr.	Silber	Tricoat		
	207150				203537			
- / + mm				- / + mm				
Schliessteile fuer G-TS			Bolzenschliesst. U-Profil	Schliessteile fuer G-TS			Bolzenschliessteil ZA	
Anpressdr.	Silber	Tricoat		Anpressdr.	Silber	Tricoat		
	207151				203550			
- / + mm				- / + mm				
Fraesabdeckungen f. Schließteile		Schwarz	Verarbeitungshinweise					
Bolzen		355399						
Haken + Zusatzschloss		355401						
Riegelschliessteil		355403						
HO BO								
Fallen - u. Riegelschliessteil								

Rechtsansprüche aus der Anwendung der in diesem Profilblatt angegebenen Artikel können nicht geltend gemacht werden. Dieses Profilblatt ersetzt keine Pruefung in einem akkreditiertem Pruefinstitut !

DU01T
DURAFLEX
X 3500_PROTECT









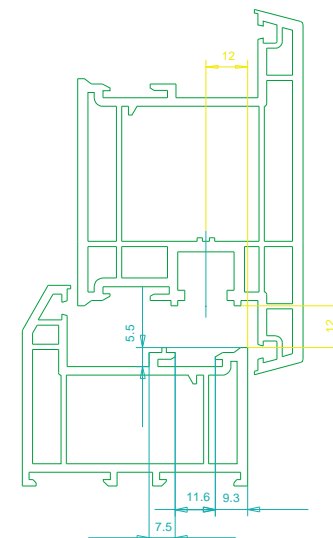



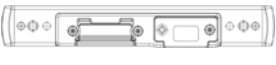
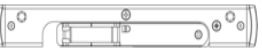

Rahmen

Fluegel

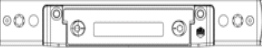
Falzlufthöhe mm: Ueberschlag mm: Versatz mm:



Schliessteilleisten U-Profil 													
Schloss	Silber	Tricoat	Silber	Tricoat	Silber	Tricoat	Silber	Tricoat	Silber	Tricoat	Silber	Tricoat	
Fuer Z-TF	2MF + 2iS		2MF + 2iS K+500		2MF + 3iS K+1030		2MF + 4iS		2MF + 4iS K+500		2MF-BO		
rechts													
links													
Fuer Z-TF	2MF-BO K+605		2MF-BO K+980		Fuer Z-TS		2 HO-BO + ZS		4 HO-BO				
rechts					rechts								
links					links								
Fuer Z-TS	3 iS + TB		2 HO-BO + TB		4 iS		3iS + ZS		2 HO-BO		2 HO-BO + 2iS		
rechts													
links													
Fuer G-TS	4 iS		2 BO		2 BO+ZS								
rechts													
links													
Schliessteile fuer Z-TS, Z-TF, G-TS					i.S. U-Profil 			Rechts		Links			
Fallen- u Riegelschliessteile								Silber	Tricoat	Silber	Tricoat		
Ausfuehrung	U-6x32x9				207172		207173						
		Rechts		Links		- / + mm							
Anpressdr.	Silber	Tricoat	Silber	Tricoat									
	209129		209130										
Exenter	209126		209127										
f. E-Oeffner													
					i.S. ZA 			355016		355041			
					- / + mm								

Schliessteile fuer Z-TF			Fallenschließteil ZT-F		MF-BO f. Z-TF				
Anpressdr.	Silber	Tricoat				Silber	Tricoat		
	209984				rechts				
Excenter	209128				links				
f. E-Oeffner									
Schliessteile fuer Z-TS			TB-Schliessteil		Schliessteile fuer Z-TS			HO-BO ZA	
	Silber	Tricoat			Anpressdr.	Silber	Tricoat		
Rechts									
Links					- / + mm				
Schliessteile fuer Z-TS			HO-BO U		Riegelschliessteil f. 2-flg. Haustueren ZA (Z-TS, Z-TF,G-TS)				
Anpressdr.	Silber	Tricoat			Anpressdr.	Silber	Tricoat		
						206932			
- / + mm					- / + mm				
Schliessteile fuer G-TS			Hakenschliesst. U-Profil		Schliessteile fuer G-TS			Hakenschliessteil ZA	
Anpressdr.	Silber	Tricoat			Anpressdr.	Silber	Tricoat		
	207170					203565			
- / + mm					- / + mm				
Schliessteile fuer G-TS			Bolzenschliesst. U-Profil		Schliessteile fuer G-TS			Bolzenschliessteil ZA	
Anpressdr.	Silber	Tricoat			Anpressdr.	Silber	Tricoat		
	207171					203590			
- / + mm					- / + mm				
Fraesabdeckungen f. Schließteile		Schwarz	Verarbeitungshinweise						
Bolzen		355399							
Haken + Zusatzschloss		355401							
Riegelschliessteil		355403							
HO BO									
Fallen - u. Riegelschliessteil									

Rechtsansprüche aus der Anwendung der in diesem Profilblatt angegebenen Artikel können nicht geltend gemacht werden. Dieses Profilblatt ersetzt keine Pruefung in einem akkreditiertem Pruefinstitut !

EC04T
EUROCELL



Logik 70 Door







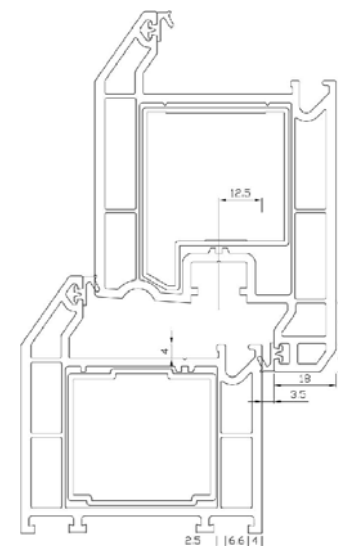

Rahmen EWS 7006;

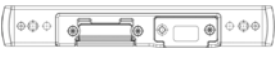
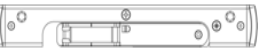
Fluegel EWS 7018;

Falzlufth mm: 12 Ueberschlag mm: 20 Versatz mm: 12.5



Schliessteilleisten U-Profil												
Schloss	Silber	Tricoat	Silber	Tricoat	Silber	Tricoat	Silber	Tricoat	Silber	Tricoat	Silber	Tricoat
Fuer Z-TF	2MF + 2iS		2MF + 2iS K+500		2MF + 3iS K+1030		2MF + 4iS		2MF + 4iS K+500		2MF-BO	
rechts												
links												
Fuer Z-TF	2MF-BO K+605		2MF-BO K+980		Fuer Z-TS		2 HO-BO + ZS		4 HO-BO			
rechts					rechts							
links					links							
Fuer Z-TS	3 iS + TB		2 HO-BO + TB		4 iS		3iS + ZS		2 HO-BO		2 HO-BO + 2iS	
rechts												
links												
Fuer G-TS	4 iS		2 BO		2 BO+ZS							
rechts												
links												
Schliessteile fuer Z-TS, Z-TF, G-TS					i.S. U-Profil			Rechts		Links		
Fallen- u Riegelschliessteile								Silber	Tricoat	Silber	Tricoat	
Ausfuehrung	U-6x32x6							- / + mm				
	Rechts		Links									
Anpressdr.	Silber	Tricoat	Silber	Tricoat								
	211059		211060									
Exenter					i.S. ZA							
f. E-Oeffner										- / + mm		

Schliessteile fuer Z-TF			Fallenschließteil ZT-F	MF-BO f. Z-TF				
Anpressdr.	Silber	Tricoat			Silber	Tricoat		
				rechts				
Excenter				links				
f. E-Oeffner								
Schliessteile fuer Z-TS			TB-Schliessteil	Schliessteile fuer Z-TS			HO-BO ZA	
	Silber	Tricoat		Anpressdr.	Silber	Tricoat		
Rechts								
Links				- / + mm				
Schliessteile fuer Z-TS			HO-BO U	Riegelschliessteil f. 2-flg. Haustueren ZA (Z-TS, Z-TF,G-TS)				
Anpressdr.	Silber	Tricoat		Anpressdr.	Silber	Tricoat		
	212298				212586			
- / + mm				- / + mm				
Schliessteile fuer G-TS			Hakenschliesst. U-Profil	Schliessteile fuer G-TS			Hakenschliessteil ZA	
Anpressdr.	Silber	Tricoat		Anpressdr.	Silber	Tricoat		
- / + mm				- / + mm				
Schliessteile fuer G-TS			Bolzenschliesst. U-Profil	Schliessteile fuer G-TS			Bolzenschliessteil ZA	
Anpressdr.	Silber	Tricoat		Anpressdr.	Silber	Tricoat		
- / + mm				- / + mm				
Fraesabdeckungen f. Schließteile		Schwarz	Verarbeitungshinweise					
Bolzen			212298 Hook strike UK silver					
Haken + Zusatzschloss			212586 Dooble slot strike UK silver					
Riegelschliessteil								
HO BO								
Fallen - u. Riegelschliessteil								

Rechtsansprüche aus der Anwendung der in diesem Profilblatt angegebenen Artikel können nicht geltend gemacht werden. Dieses Profilblatt ersetzt keine Pruefung in einem akkreditiertem Pruefinstitut !

GE03T
 GEALAN
 S 8000 IQ_PROTECT







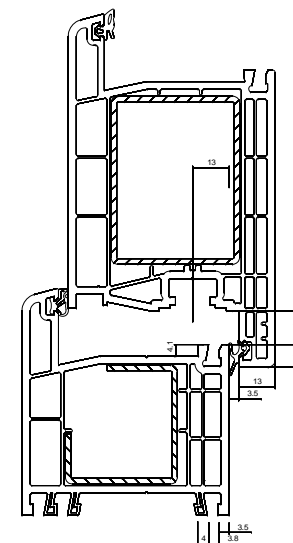

Rahmen

Fluegel

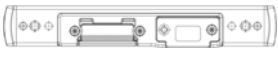
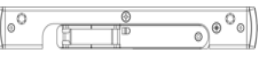
Falzluft mm: Ueberschlag mm: Versatz mm:

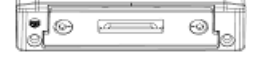

Schliessteilleisten U-Profil												
Schloss	Silber	Tricoat	Silber	Tricoat	Silber	Tricoat	Silber	Tricoat	Silber	Tricoat	Silber	Tricoat
Fuer Z-TF	2MF + 2iS		2MF + 2iS K+500		2MF + 3iS K+1030		2MF + 4iS		2MF + 4iS K+500		2MF-BO	
rechts	207831		213377		213379		213381		213383		215312	
links	207830		213378		213380		213382		213384		215313	
Fuer Z-TF	2MF-BO K+605		2MF-BO K+980		Fuer Z-TS		2 HO-BO + ZS		4 HO-BO			
rechts	215314		215316		rechts				213676			
links	215315		215317		links				213677			
Fuer Z-TS	3 iS + TB		2 HO-BO + TB		4 iS		3iS + ZS		2 HO-BO		2 HO-BO + 2iS	
rechts	214341		214355		207583		207839		207832			
links	214342		214356		207582		207838		207833			
Fuer G-TS	4 iS		2 BO		2 BO+ZS							
rechts	207583		207845		207837							
links	207582		207844		207836							
Schliessteile fuer Z-TS, Z-TF, G-TS					i.S. U-Profil			Rechts		Links		
Fallen- u Riegelschliessteile								Silber	Tricoat	Silber	Tricoat	
Ausfuehrung	U-6x32x9						207148		207149			
		Rechts		Links		- / + mm						
Anpressdr.	Silber	Tricoat	Silber	Tricoat								
	209134		209135									
Exenter	209131		209132									
f. E-Oeffner					i.S. ZA			355498		355510		
						- / + mm						

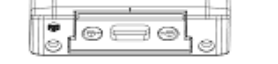
Schliessteile fuer Z-TF			Fallenschließteil ZT-F	MF-BO f. Z-TF				
Anpressdr.	Silber	Tricoat			Silber	Tricoat		
	209985			rechts	215252			
Excenter	209133			links	215253			
f. E-Oeffner								
Schliessteile fuer Z-TS			TB-Schliessteil	Schliessteile fuer Z-TS			HO-BO ZA	
	Silber	Tricoat		Anpressdr.	Silber	Tricoat		
Rechts	214369				211550			
Links	214370			- / + mm	217616			-2
Schliessteile fuer Z-TS			HO-BO U	Riegelschliessteil f. 2-flg. Haustueren ZA (Z-TS, Z-TF,G-TS)				
Anpressdr.	Silber	Tricoat		Anpressdr.	Silber	Tricoat		
					206927			
- / + mm				- / + mm				
Schliessteile fuer G-TS			Hakenschliesst. U-Profil	Schliessteile fuer G-TS			Hakenschliessteil ZA	
Anpressdr.	Silber	Tricoat		Anpressdr.	Silber	Tricoat		
	207146				204082			
- / + mm				- / + mm				
Schliessteile fuer G-TS			Bolzenschliesst. U-Profil	Schliessteile fuer G-TS			Bolzenschliessteil ZA	
Anpressdr.	Silber	Tricoat		Anpressdr.	Silber	Tricoat		
	207147				204072			
- / + mm				- / + mm	209718			+2
Fraesabdeckungen f. Schließteile		Schwarz	Verarbeitungshinweise					
Bolzen		355399						
Haken + Zusatzschloss		355401						
Riegelschliessteil		355403						
HO BO		358027						
Fallen - u. Riegelschliessteil								

Rechtsansprüche aus der Anwendung der in diesem Profilblatt angegebenen Artikel können nicht geltend gemacht werden. Dieses Profilblatt ersetzt keine Pruefung in einem akkreditiertem Pruefinstitut !

GE02T
GEALAN





3000_PROTECT





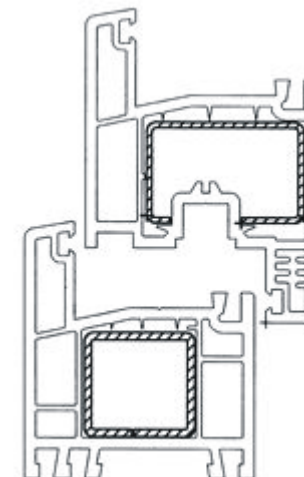

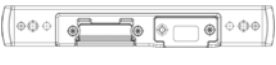
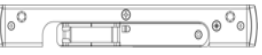

Rahmen

Fluegel

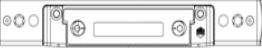
Falzlufth mm: Ueberschlag mm: Versatz mm:



Schliessteilleisten U-Profil												
Schloss	Silber	Tricoat	Silber	Tricoat	Silber	Tricoat	Silber	Tricoat	Silber	Tricoat	Silber	Tricoat
Fuer Z-TF	2MF + 2iS		2MF + 2iS K+500		2MF + 3iS K+1030		2MF + 4iS		2MF + 4iS K+500		2MF-BO	
rechts	207831		213377		213379		213381		213383		215312	
links	207830		213378		213380		213382		213384		215313	
Fuer Z-TF	2MF-BO K+605		2MF-BO K+980		Fuer Z-TS		2 HO-BO + ZS		4 HO-BO			
rechts	215314		215316		rechts				213676			
links	215315		215317		links				213677			
Fuer Z-TS	3 iS + TB		2 HO-BO + TB		4 iS		3iS + ZS		2 HO-BO		2 HO-BO + 2iS	
rechts	214341		214355		207583		207839		207832			
links	214342		214356		207582		207838		207833			
Fuer G-TS	4 iS		2 BO		2 BO+ZS							
rechts	207583		207845		207837							
links	207582		207844		207836							
Schliessteile fuer Z-TS, Z-TF, G-TS					i.S. U-Profil			Rechts		Links		
Fallen- u Riegelschliessteile								Silber	Tricoat	Silber	Tricoat	
Ausfuehrung	U-6x32x9						207148		207149			
					- / + mm							
Anpressdr.	Silber	Tricoat	Silber	Tricoat								
	209134		209135									
Exenter	209131		209132									
f. E-Oeffner												
					i.S. ZA			355498		355510		

Schliessteile fuer Z-TF			Fallenschließteil ZT-F	MF-BO f. Z-TF				
Anpressdr.	Silber	Tricoat			Silber	Tricoat		
	209985			rechts	215252			
Excenter	209133			links	215253			
f. E-Oeffner								
Schliessteile fuer Z-TS			TB-Schliessteil	Schliessteile fuer Z-TS			HO-BO ZA	
	Silber	Tricoat		Anpressdr.	Silber	Tricoat		
Rechts	214369				211550			
Links	214370			- / + mm				
Schliessteile fuer Z-TS			HO-BO U	Riegelschliessteil f. 2-flg. Haustueren ZA (Z-TS, Z-TF,G-TS)				
Anpressdr.	Silber	Tricoat		Anpressdr.	Silber	Tricoat		
					206927			
- / + mm				- / + mm				
Schliessteile fuer G-TS			Hakenschliesst. U-Profil	Schliessteile fuer G-TS			Hakenschliessteil ZA	
Anpressdr.	Silber	Tricoat		Anpressdr.	Silber	Tricoat		
	207146				204082			
- / + mm				- / + mm				
Schliessteile fuer G-TS			Bolzenschliesst. U-Profil	Schliessteile fuer G-TS			Bolzenschliessteil ZA	
Anpressdr.	Silber	Tricoat		Anpressdr.	Silber	Tricoat		
	207147				204072			
- / + mm				- / + mm				
Fraesabdeckungen f. Schließteile		Schwarz	Verarbeitungshinweise					
Bolzen		355399						
Haken + Zusatzschloss		355401						
Riegelschliessteil		355403						
HO BO		358027						
Fallen - u. Riegelschliessteil								

Rechtsansprüche aus der Anwendung der in diesem Profilblatt angegebenen Artikel können nicht geltend gemacht werden. Dieses Profilblatt ersetzt keine Pruefung in einem akkreditiertem Pruefinstitut !

HR04T
HEROAL
System 90S_PROTECT









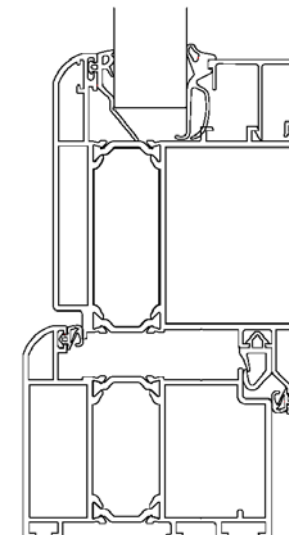



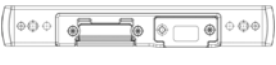
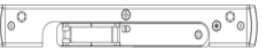

Rahmen

Fluegel

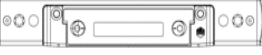
Falzluft mm: Ueberschlag mm: Versatz mm:



Schliessteilleisten U-Profil 												
Schloss	Silber	Tricoat	Silber	Tricoat	Silber	Tricoat	Silber	Tricoat	Silber	Tricoat	Silber	Tricoat
Fuer Z-TF	2MF + 2iS		2MF + 2iS K+500		2MF + 3iS K+1030		2MF + 4iS		2MF + 4iS K+500		2MF-BO	
rechts											218134	
links											218135	
Fuer Z-TF	2MF-BO K+605		2MF-BO K+980		Fuer Z-TS		2 HO-BO + ZS		4 HO-BO			
rechts	218136		218138		rechts				208470			
links	218137		218139		links				208471			
Fuer Z-TS	3 iS + TB		2 HO-BO + TB		4 iS		3iS + ZS		2 HO-BO		2 HO-BO + 2iS	
rechts									208468			
links									208469			
Fuer G-TS	4 iS		2 BO		2 BO+ZS							
rechts												
links												
Schliessteile fuer Z-TS, Z-TF, G-TS					i.S. U-Profil 			Rechts		Links		
Fallen- u Riegelschliessteile								Silber	Tricoat	Silber	Tricoat	
Ausfuehrung								- / + mm				
		Rechts		Links								
Anpressdr.	Silber	Tricoat	Silber	Tricoat								
	214693		214694									
i.S. ZA 												
Exenter												
f. E-Oeffner												
					- / + mm							

Schliessteile fuer Z-TF			Fallenschließteil ZT-F		MF-BO f. Z-TF				
Anpressdr.	Silber	Tricoat				Silber	Tricoat		
					rechts	102998			
Excenter					links				
f. E-Oeffner									
Schliessteile fuer Z-TS			TB-Schliessteil		Schliessteile fuer Z-TS			HO-BO ZA	
	Silber	Tricoat			Anpressdr.	Silber	Tricoat		
Rechts						213180			
Links					- / + mm				
Schliessteile fuer Z-TS			HO-BO U		Riegelschliessteil f. 2-flg. Haustueren ZA (Z-TS, Z-TF,G-TS)				
Anpressdr.	Silber	Tricoat			Anpressdr.	Silber	Tricoat		
					- / + mm				
- / + mm									
Schliessteile fuer G-TS			Hakenschliesst. U-Profil		Schliessteile fuer G-TS			Hakenschliessteil ZA	
Anpressdr.	Silber	Tricoat			Anpressdr.	Silber	Tricoat		
					- / + mm				
- / + mm									
Schliessteile fuer G-TS			Bolzenschliesst. U-Profil		Schliessteile fuer G-TS			Bolzenschliessteil ZA	
Anpressdr.	Silber	Tricoat			Anpressdr.	Silber	Tricoat		
					- / + mm				
- / + mm									
Fraesabdeckungen f. Schließteile		Schwarz	Verarbeitungshinweise						
Bolzen			361825 Fallenaufwurf f. aussenoeffnende Tueren						
Haken + Zusatzschloss			Haustuerkantriegel: 213831 rechts, 213832 links						
Riegelschliessteil			58667 Riegelschliessteil 1 Schlitz						
HO BO									
Fallen - u. Riegelschliessteil									

Rechtsansprüche aus der Anwendung der in diesem Profilblatt angegebenen Artikel können nicht geltend gemacht werden. Dieses Profilblatt ersetzt keine Pruefung in einem akkreditiertem Pruefinstitut !





TH01T
INOUSIC (THYSSEN)
AD_PROTECT









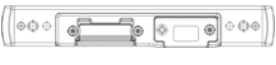

Rahmen

Fluegel

Falzluft mm: Ueberschlag mm: Versatz mm:

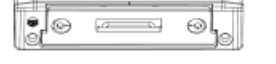
Schliessteilleisten U-Profil 												
Schloss	Silber	Tricoat	Silber	Tricoat	Silber	Tricoat	Silber	Tricoat	Silber	Tricoat	Silber	Tricoat
Fuer Z-TF	2MF + 2iS		2MF + 2iS K+500		2MF + 3iS K+1030		2MF + 4iS		2MF + 4iS K+500		2MF-BO	
rechts	210740		213732		213734		213736		213738		216316	
links	210741		213733		213735		213737		213739		216317	
Fuer Z-TF	2MF-BO K+605		2MF-BO K+980		Fuer Z-TS		2 HO-BO + ZS		4 HO-BO			
rechts	216318		216320		rechts				213672			
links	216319		216321		links				213673			
Fuer Z-TS	3 iS + TB		2 HO-BO + TB		4 iS		3iS + ZS		2 HO-BO		2 HO-BO + 2iS	
rechts			216791		208523		208517		208464			
links			216792		208522		208516		208465			
Fuer G-TS	4 iS		2 BO		2 BO+ZS							
rechts	208523		208519		208515							
links	208522		208518		208514							
Schliessteile fuer Z-TS, Z-TF, G-TS					i.S. U-Profil 			Rechts		Links		
Fallen- u Riegelschliessteile								Silber	Tricoat	Silber	Tricoat	
Ausfuehrung	U-6x32x9				207164		207165					
		Rechts		Links		- / + mm						
Anpressdr.	Silber	Tricoat	Silber	Tricoat								
	209179		209180									
Exenter	209176		209177									
f. E-Oeffner												
					i.S. ZA 			354992		355005		
								- / + mm				

Schliessteile fuer Z-TF			Fallenschließteil ZT-F	MF-BO f. Z-TF				
Anpressdr.	Silber	Tricoat			Silber	Tricoat		
	209991			rechts	216322			
Excenter	209178			links	216323			
f. E-Oeffner								
Schliessteile fuer Z-TS			TB-Schliessteil	Schliessteile fuer Z-TS			HO-BO ZA	
	Silber	Tricoat		Anpressdr.	Silber	Tricoat		
Rechts	216789				211555			
Links	216790			- / + mm				
Schliessteile fuer Z-TS			HO-BO U	Riegelschliessteil f. 2-flg. Haustueren ZA (Z-TS, Z-TF,G-TS)				
Anpressdr.	Silber	Tricoat		Anpressdr.	Silber	Tricoat		
					206929			
- / + mm				- / + mm				
Schliessteile fuer G-TS			Hakenschliesst. U-Profil	Schliessteile fuer G-TS			Hakenschliessteil ZA	
Anpressdr.	Silber	Tricoat		Anpressdr.	Silber	Tricoat		
	207162				203543			
- / + mm				- / + mm				
Schliessteile fuer G-TS			Bolzenschliesst. U-Profil	Schliessteile fuer G-TS			Bolzenschliessteil ZA	
Anpressdr.	Silber	Tricoat		Anpressdr.	Silber	Tricoat		
	207163				203556			
- / + mm				- / + mm				
Fraesabdeckungen f. Schließteile		Schwarz	Verarbeitungshinweise					
Bolzen		355399						
Haken + Zusatzschloss		355401						
Riegelschliessteil		355403						
HO BO		358027						
Fallen - u. Riegelschliessteil								

Rechtsansprüche aus der Anwendung der in diesem Profilblatt angegebenen Artikel können nicht geltend gemacht werden. Dieses Profilblatt ersetzt keine Pruefung in einem akkreditiertem Pruefinstitut !





TH04T
INOUSIC (THYSSEN)
Prestige_PROTECT









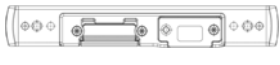
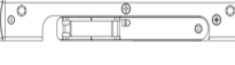

Rahmen

Fluegel

Falzluft mm: Ueberschlag mm: Versatz mm:

Schliessteilleisten U-Profil 												
Schloss	Silber	Tricoat	Silber	Tricoat	Silber	Tricoat	Silber	Tricoat	Silber	Tricoat	Silber	Tricoat
Fuer Z-TF	2MF + 2iS		2MF + 2iS K+500		2MF + 3iS K+1030		2MF + 4iS		2MF + 4iS K+500		2MF-BO	
rechts	210740		213732		213734		213736		213738		216316	
links	210741		213733		213735		213737		213739		216317	
Fuer Z-TF	2MF-BO K+605		2MF-BO K+980		Fuer Z-TS		2 HO-BO + ZS		4 HO-BO			
rechts	216318		216320		rechts				213672			
links	216319		216321		links				213673			
Fuer Z-TS	3 iS + TB		2 HO-BO + TB		4 iS		3iS + ZS		2 HO-BO		2 HO-BO + 2iS	
rechts			216791		208523		208517		208464			
links			216792		208522		208516		208465			
Fuer G-TS	4 iS		2 BO		2 BO+ZS							
rechts	208523		208519		208515							
links	208522		208518		208514							
Schliessteile fuer Z-TS, Z-TF, G-TS					i.S. U-Profil 			Rechts		Links		
Fallen- u Riegelschliessteile								Silber	Tricoat	Silber	Tricoat	
Ausfuehrung		U-6x32x9					207164		207165			
		Rechts		Links				- / + mm				
Anpressdr.	Silber	Tricoat	Silber	Tricoat								
	209179		209180									
Exenter	209176		209177									
f. E-Oeffner												
					i.S. ZA 			354992		355005		
								- / + mm				

Schliessteile fuer Z-TF			Fallenschließteil ZT-F		MF-BO f. Z-TF				
Anpressdr.	Silber	Tricoat				Silber	Tricoat		
	209991				rechts	216322			
Excenter	209178				links	216323			
f. E-Oeffner									
Schliessteile fuer Z-TS			TB-Schliessteil		Schliessteile fuer Z-TS			HO-BO ZA	
	Silber	Tricoat			Anpressdr.	Silber	Tricoat		
Rechts	216789					211555			
Links	216790				- / + mm				
Schliessteile fuer Z-TS			HO-BO U		Riegelschliessteil f. 2-flg. Haustueren ZA (Z-TS, Z-TF,G-TS)				
Anpressdr.	Silber	Tricoat			Anpressdr.	Silber	Tricoat		
						206929			
- / + mm					- / + mm				
Schliessteile fuer G-TS			Hakenschliesst. U-Profil		Schliessteile fuer G-TS			Hakenschliessteil ZA	
Anpressdr.	Silber	Tricoat			Anpressdr.	Silber	Tricoat		
	207162					203543			
- / + mm					- / + mm				
Schliessteile fuer G-TS			Bolzenschliesst. U-Profil		Schliessteile fuer G-TS			Bolzenschliessteil ZA	
Anpressdr.	Silber	Tricoat			Anpressdr.	Silber	Tricoat		
	207163					203556			
- / + mm					- / + mm				
Fraesabdeckungen f. Schließteile		Schwarz	Verarbeitungshinweise						
Bolzen		355399							
Haken + Zusatzschloss		355401							
Riegelschliessteil		355403							
HO BO		358027							
Fallen - u. Riegelschliessteil									

Rechtsansprüche aus der Anwendung der in diesem Profilblatt angegebenen Artikel können nicht geltend gemacht werden. Dieses Profilblatt ersetzt keine Pruefung in einem akkreditiertem Pruefinstitut !

IT02T
ITALPLASTICK
System MD 70









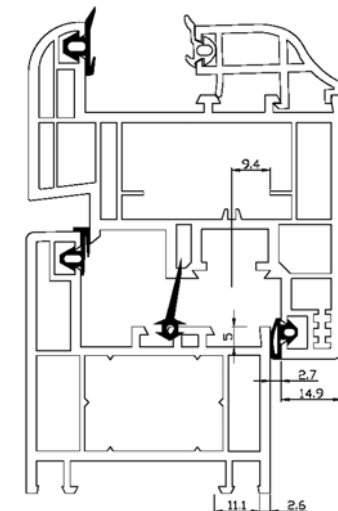



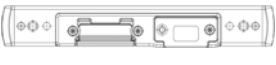
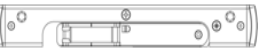

Rahmen

Fluegel

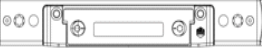
Falzlufth mm: Ueberschlag mm: Versatz mm:



Schliessteilleisten U-Profil 													
Schloss	Silber	Tricoat	Silber	Tricoat	Silber	Tricoat	Silber	Tricoat	Silber	Tricoat	Silber	Tricoat	
Fuer Z-TF	2MF + 2iS		2MF + 2iS K+500		2MF + 3iS K+1030		2MF + 4iS		2MF + 4iS K+500		2MF-BO		
rechts													
links													
Fuer Z-TF	2MF-BO K+605		2MF-BO K+980		Fuer Z-TS		2 HO-BO + ZS		4 HO-BO				
rechts					rechts								
links					links								
Fuer Z-TS	3 iS + TB		2 HO-BO + TB		4 iS		3iS + ZS		2 HO-BO		2 HO-BO + 2iS		
rechts													
links													
Fuer G-TS	4 iS		2 BO		2 BO+ZS								
rechts													
links													
Schliessteile fuer Z-TS, Z-TF, G-TS					 i.S. U-Profil			Rechts		Links			
Fallen- u Riegelschliessteile								Silber	Tricoat	Silber	Tricoat		
Ausfuehrung								- / + mm					
		Rechts		Links									
Anpressdr.	Silber	Tricoat	Silber	Tricoat									
					 i.S. ZA								
Exenter								- / + mm					
f. E-Oeffner		217680		217681									

Schliessteile fuer Z-TF			Fallenschließteil ZT-F		MF-BO f. Z-TF				
Anpressdr.	Silber	Tricoat				Silber	Tricoat		
					rechts	103399			
Excenter					links	103399			
f. E-Oeffner	217682								
Schliessteile fuer Z-TS			TB-Schliessteil		Schliessteile fuer Z-TS			HO-BO ZA	
	Silber	Tricoat			Anpressdr.	Silber	Tricoat		
Rechts						217683			
Links					- / + mm				
Schliessteile fuer Z-TS			HO-BO U		Riegelschliessteil f. 2-flg. Haustueren ZA (Z-TS, Z-TF,G-TS)				
Anpressdr.	Silber	Tricoat			Anpressdr.	Silber	Tricoat		
						217684			
- / + mm					- / + mm				
Schliessteile fuer G-TS			Hakenschliesst. U-Profil		Schliessteile fuer G-TS			Hakenschliessteil ZA	
Anpressdr.	Silber	Tricoat			Anpressdr.	Silber	Tricoat		
					- / + mm				
- / + mm									
Schliessteile fuer G-TS			Bolzenschliesst. U-Profil		Schliessteile fuer G-TS			Bolzenschliessteil ZA	
Anpressdr.	Silber	Tricoat			Anpressdr.	Silber	Tricoat		
					- / + mm				
- / + mm									
Fraesabdeckungen f. Schließteile		Schwarz	Verarbeitungshinweise						
Bolzen									
Haken + Zusatzschloss									
Riegelschliessteil									
HO BO									
Fallen - u. Riegelschliessteil									

Rechtsansprüche aus der Anwendung der in diesem Profilblatt angegebenen Artikel können nicht geltend gemacht werden. Dieses Profilblatt ersetzt keine Pruefung in einem akkreditiertem Pruefinstitut !

JO01T
JOSKO













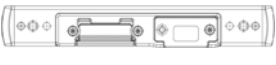
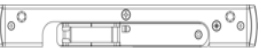

Proline 85_PROTECT

Rahmen

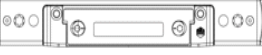
Fluegel

Falzluft mm: Ueberschlag mm: Versatz mm:

Schliessteilleisten U-Profil 												
Schloss	Silber	Tricoat	Silber	Tricoat	Silber	Tricoat	Silber	Tricoat	Silber	Tricoat	Silber	Tricoat
Fuer Z-TF	2MF + 2iS		2MF + 2iS K+500		2MF + 3iS K+1030		2MF + 4iS		2MF + 4iS K+500		2MF-BO	
rechts												
links												
Fuer Z-TF	2MF-BO K+605		2MF-BO K+980		Fuer Z-TS		2 HO-BO + ZS		4 HO-BO			
rechts					rechts							
links					links							
Fuer Z-TS	3 iS + TB		2 HO-BO + TB		4 iS		3iS + ZS		2 HO-BO		2 HO-BO + 2iS	
rechts												
links												
Fuer G-TS	4 iS		2 BO		2 BO+ZS							
rechts												
links												
Schliessteile fuer Z-TS, Z-TF, G-TS					i.S. U-Profil 			Rechts		Links		
Fallen- u Riegelschliessteile								Silber	Tricoat	Silber	Tricoat	
Ausfuehrung		U-6x24x6						- / + mm				
	Rechts		Links									
Anpressdr.	Silber	Tricoat	Silber	Tricoat								
	215194		215206									
Exenter												
f. E-Oeffner	213852		213853									
					i.S. ZA 			- / + mm				

Schliessteile fuer Z-TF			Fallenschließteil ZT-F	MF-BO f. Z-TF				
Anpressdr.	Silber	Tricoat			Silber	Tricoat		
	215496			rechts				
Excenter				links				
f. E-Oeffner	215496							
Schliessteile fuer Z-TS			TB-Schliessteil	Schliessteile fuer Z-TS			HO-BO ZA	
	Silber	Tricoat		Anpressdr.	Silber	Tricoat		
Rechts								
Links				- / + mm				
Schliessteile fuer Z-TS			HO-BO U	Riegelschliessteil f. 2-flg. Haustueren ZA (Z-TS, Z-TF,G-TS)				
Anpressdr.	Silber	Tricoat		Anpressdr.	Silber	Tricoat		
				- / + mm				
- / + mm								
Schliessteile fuer G-TS			Hakenschliesst. U-Profil	Schliessteile fuer G-TS			Hakenschliessteil ZA	
Anpressdr.	Silber	Tricoat		Anpressdr.	Silber	Tricoat		
				- / + mm				
- / + mm								
Schliessteile fuer G-TS			Bolzenschliesst. U-Profil	Schliessteile fuer G-TS			Bolzenschliessteil ZA	
Anpressdr.	Silber	Tricoat		Anpressdr.	Silber	Tricoat		
				- / + mm				
- / + mm								
Fraesabdeckungen f. Schließteile		Schwarz	Verarbeitungshinweise					
Bolzen			215194, 215206, 215496 f. E-Oeffner eff 118.13A71 Profix2					
Haken + Zusatzschloss			Auslaufende Artikel: Schliessteil f. Falle u. Riegel silber					
Riegelschliessteil			211164 rechts, 211165 links, Fallenschliessteil MF: 211182					
HO BO			F. E-Oeffner effeff 118E.15 --- A71 Profix2					
Fallen - u. Riegelschliessteil			213852 rechts, 213853 links, Fallenschliessteil MF: 213854					

Rechtsansprüche aus der Anwendung der in diesem Profilblatt angegebenen Artikel können nicht geltend gemacht werden. Dieses Profilblatt ersetzt keine Pruefung in einem akkreditiertem Pruefinstitut !

KB15T

KBE

System 70 AD UK_PROTECT









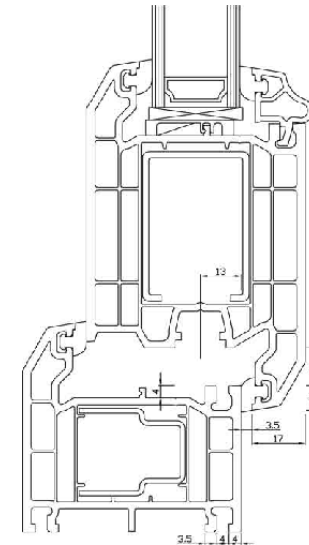



Rahmen

Fluegel

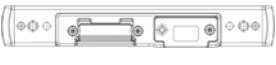
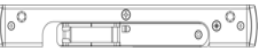
Falzluft mm: Ueberschlag mm: Versatz mm:

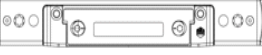

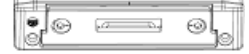
Schliessteilleisten U-Profil 														
Schloss	Silber	Tricoat	Silber	Tricoat	Silber	Tricoat	Silber	Tricoat	Silber	Tricoat	Silber	Tricoat		
Fuer Z-TF	2MF + 2iS		2MF + 2iS K+500		2MF + 3iS K+1030		2MF + 4iS		2MF + 4iS K+500		2MF-BO			
rechts														
links														
Fuer Z-TF	2MF-BO K+605		2MF-BO K+980		Fuer Z-TS		2 HO-BO + ZS		4 HO-BO					
rechts					rechts									
links					links									
Fuer Z-TS	3 iS + TB		2 HO-BO + TB		4 iS		3iS + ZS		2 HO-BO		2 HO-BO + 2iS			
rechts														
links														
Fuer G-TS	4 iS		2 BO		2 BO+ZS									
rechts														
links														
Schliessteile fuer Z-TS, Z-TF, G-TS					 i.S. U-Profil		Rechts		Links					
Fallen- u Riegelschliessteile							Silber	Tricoat	Silber	Tricoat				
Ausfuehrung									- / + mm					
Anpressdr.	Silber	Tricoat	Silber	Tricoat										
	209139		209140											
Exenter					 i.S. ZA									
f. E-Oeffner														

Schliessteile fuer Z-TF			Fallenschließteil ZT-F	MF-BO f. Z-TF					
Anpressdr.	Silber	Tricoat			Silber	Tricoat			
				rechts					
Excenter				links					
f. E-Oeffner									
Schliessteile fuer Z-TS			TB-Schliessteil	Schliessteile fuer Z-TS			HO-BO ZA		
	Silber	Tricoat		Anpressdr.	Silber	Tricoat			
Rechts									
Links				- / + mm					
Schliessteile fuer Z-TS			HO-BO U	Riegelschliessteil f. 2-flg. Haustueren ZA (Z-TS, Z-TF,G-TS)					
Anpressdr.	Silber	Tricoat		Anpressdr.	Silber	Tricoat			
				- / + mm					
- / + mm									
Schliessteile fuer G-TS			Hakenschliesst. U-Profil	Schliessteile fuer G-TS			Hakenschliessteil ZA		
Anpressdr.	Silber	Tricoat		Anpressdr.	Silber	Tricoat			
				- / + mm					
- / + mm									
Schliessteile fuer G-TS			Bolzenschliesst. U-Profil	Schliessteile fuer G-TS			Bolzenschliessteil ZA		
Anpressdr.	Silber	Tricoat		Anpressdr.	Silber	Tricoat			
				- / + mm					
- / + mm									
Fraesabdeckungen f. Schließteile		Schwarz	Verarbeitungshinweise						
Bolzen									
Haken + Zusatzschloss									
Riegelschliessteil									
HO BO									
Fallen - u. Riegelschliessteil									

Rechtsansprüche aus der Anwendung der in diesem Profilblatt angegebenen Artikel können nicht geltend gemacht werden. Dieses Profilblatt ersetzt keine Pruefung in einem akkreditiertem Pruefinstitut !

KB07T

KBE

System 70 AD_PROTECT







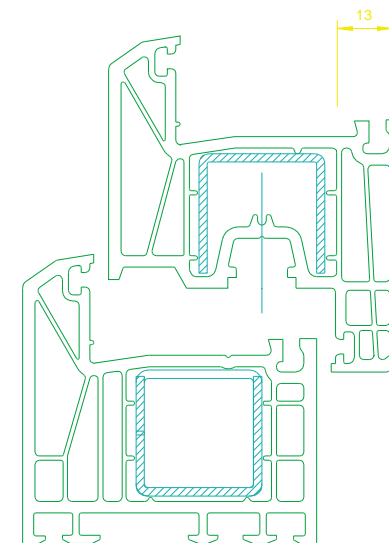

Rahmen 370 - 372

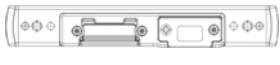
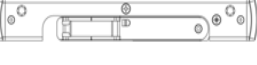
Fluegel 373, 375, 376, 378;

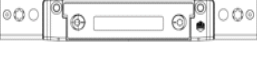
Falzlufth mm: 12 Ueberschlag mm: 20 Versatz mm: 13



Schliessteilleisten U-Profil													
Schloss	Silber	Tricoat	Silber	Tricoat	Silber	Tricoat	Silber	Tricoat	Silber	Tricoat	Silber	Tricoat	
Fuer Z-TF	2MF + 2iS		2MF + 2iS K+500		2MF + 3iS K+1030		2MF + 4iS		2MF + 4iS K+500		2MF-BO		
rechts	210744		213839		213841		213843		213845		216049		
links	210745		213840		213842		213844		213846		216048		
Fuer Z-TF	2MF-BO K+605		2MF-BO K+980		Fuer Z-TS		2 HO-BO + ZS		4 HO-BO				
rechts	216047		216045		rechts	213803							
links	216046		216044		links	213804							
Fuer Z-TS	3 iS + TB		2 HO-BO + TB		4 iS		3iS + ZS		2 HO-BO		2 HO-BO + 2iS		
rechts					213797		213799		213801				
links					213798		213800		213802				
Fuer G-TS	4 iS		2 BO		2 BO+ZS								
rechts	213797												
links	213798												
Schliessteile fuer Z-TS, Z-TF, G-TS					i.S. U-Profil		Rechts		Links				
Fallen- u Riegelschliessteile							Silber	Tricoat	Silber	Tricoat			
Ausfuehrung	U-6x32x9				205708		205713						
	Rechts		Links										
Anpressdr.	Silber	Tricoat	Silber	Tricoat									
	209139		209140										
Exenter	209136		209137										
f. E-Oeffner													
					i.S. ZA		355023		355048				

Schliessteile fuer Z-TF			Fallenschließteil ZT-F		MF-BO f. Z-TF				
Anpressdr.	Silber	Tricoat			Silber	Tricoat			
	209987			rechts	216043				
Excenter	209138			links	216042				
f. E-Oeffner									
Schliessteile fuer Z-TS			TB-Schliessteil		Schliessteile fuer Z-TS			HO-BO ZA	
	Silber	Tricoat		Anpressdr.	Silber	Tricoat			
Rechts	215432				211551				
Links	215433			- / + mm					
Schliessteile fuer Z-TS			HO-BO U		Riegelschliessteil f. 2-flg. Haustueren ZA (Z-TS, Z-TF,G-TS)				
Anpressdr.	Silber	Tricoat		Anpressdr.	Silber	Tricoat			
					206933				
- / + mm				- / + mm					
Schliessteile fuer G-TS			Hakenschliesst. U-Profil		Schliessteile fuer G-TS			Hakenschliessteil ZA	
Anpressdr.	Silber	Tricoat		Anpressdr.	Silber	Tricoat			
	207176				203572				
- / + mm				- / + mm					
Schliessteile fuer G-TS			Bolzenschliesst. U-Profil		Schliessteile fuer G-TS			Bolzenschliessteil ZA	
Anpressdr.	Silber	Tricoat		Anpressdr.	Silber	Tricoat			
	207175				203597				
- / + mm				- / + mm					
Fraesabdeckungen f. Schließteile			Schwarz	Verarbeitungshinweise					
Bolzen			355399						
Haken + Zusatzschloss			355401						
Riegelschliessteil			355403						
HO BO			358027						
Fallen - u. Riegelschliessteil									

Rechtsansprüche aus der Anwendung der in diesem Profilblatt angegebenen Artikel können nicht geltend gemacht werden. Dieses Profilblatt ersetzt keine Pruefung in einem akkreditiertem Pruefinstitut !

KOE20T
KÖMMERLING







O70 System Gold



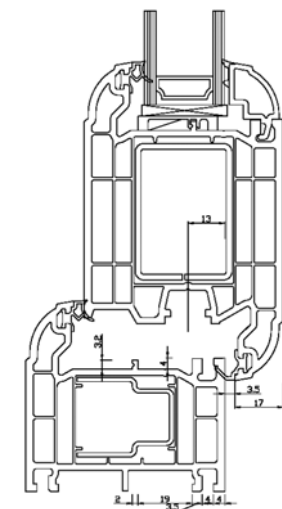



Rahmen

Fluegel

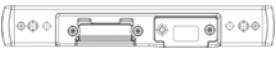
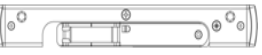
Falzluft mm: Ueberschlag mm: Versatz mm:

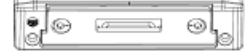

Schliessteilleisten U-Profil 												
Schloss	Silber	Tricoat	Silber	Tricoat	Silber	Tricoat	Silber	Tricoat	Silber	Tricoat	Silber	Tricoat
Fuer Z-TF	2MF + 2iS		2MF + 2iS K+500		2MF + 3iS K+1030		2MF + 4iS		2MF + 4iS K+500		2MF-BO	
rechts												
links												
Fuer Z-TF	2MF-BO K+605		2MF-BO K+980		Fuer Z-TS		2 HO-BO + ZS		4 HO-BO			
rechts					rechts							
links					links							
Fuer Z-TS	3 iS + TB		2 HO-BO + TB		4 iS		3iS + ZS		2 HO-BO		2 HO-BO + 2iS	
rechts												
links												
Fuer G-TS	4 iS		2 BO		2 BO+ZS							
rechts												
links												
Schliessteile fuer Z-TS, Z-TF, G-TS					i.S. U-Profil 			Rechts		Links		
Fallen- u Riegelschliessteile								Silber	Tricoat	Silber	Tricoat	
Ausfuehrung								- / + mm				
		Rechts		Links								
Anpressdr.	Silber	Tricoat	Silber	Tricoat								
					i.S. ZA 							
Exenter										- / + mm		
f. E-Oeffner												

Schliessteile fuer Z-TF			Fallenschließteil ZT-F	MF-BO f. Z-TF				
Anpressdr.	Silber	Tricoat			Silber	Tricoat		
				rechts				
Excenter				links				
f. E-Oeffner								
Schliessteile fuer Z-TS			TB-Schliessteil	Schliessteile fuer Z-TS			HO-BO ZA	
	Silber	Tricoat		Anpressdr.	Silber	Tricoat		
Rechts								
Links				- / + mm				
Schliessteile fuer Z-TS			HO-BO U	Riegelschliessteil f. 2-flg. Haustueren ZA (Z-TS, Z-TF,G-TS)				
Anpressdr.	Silber	Tricoat		Anpressdr.	Silber	Tricoat		
				- / + mm				
- / + mm								
Schliessteile fuer G-TS			Hakenschliesst. U-Profil	Schliessteile fuer G-TS			Hakenschliessteil ZA	
Anpressdr.	Silber	Tricoat		Anpressdr.	Silber	Tricoat		
				- / + mm				
- / + mm								
Schliessteile fuer G-TS			Bolzenschliesst. U-Profil	Schliessteile fuer G-TS			Bolzenschliessteil ZA	
Anpressdr.	Silber	Tricoat		Anpressdr.	Silber	Tricoat		
				- / + mm				
- / + mm								
Fraesabdeckungen f. Schließteile		Schwarz	Verarbeitungshinweise					
Bolzen								
Haken + Zusatzschloss								
Riegelschliessteil								
HO BO								
Fallen - u. Riegelschliessteil								

Rechtsansprüche aus der Anwendung der in diesem Profilblatt angegebenen Artikel können nicht geltend gemacht werden. Dieses Profilblatt ersetzt keine Pruefung in einem akkreditiertem Pruefinstitut !

KOE21T
KÖMMERLING
C70 System Gold









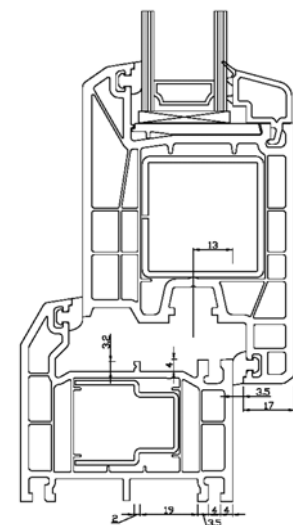



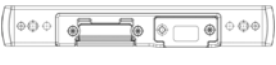
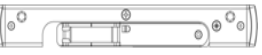

Rahmen

Fluegel

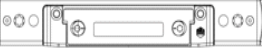
Falzluft mm: Ueberschlag mm: Versatz mm:



Schliessteilleisten U-Profil 													
Schloss	Silber	Tricoat	Silber	Tricoat	Silber	Tricoat	Silber	Tricoat	Silber	Tricoat	Silber	Tricoat	
Fuer Z-TF	2MF + 2iS		2MF + 2iS K+500		2MF + 3iS K+1030		2MF + 4iS		2MF + 4iS K+500		2MF-BO		
rechts													
links													
Fuer Z-TF	2MF-BO K+605		2MF-BO K+980		Fuer Z-TS		2 HO-BO + ZS		4 HO-BO				
rechts					rechts								
links					links								
Fuer Z-TS	3 iS + TB		2 HO-BO + TB		4 iS		3iS + ZS		2 HO-BO		2 HO-BO + 2iS		
rechts													
links													
Fuer G-TS	4 iS		2 BO		2 BO+ZS								
rechts													
links													
Schliessteile fuer Z-TS, Z-TF, G-TS					 i.S. U-Profil 		Rechts		Links				
Fallen- u Riegelschliessteile							Silber	Tricoat	Silber	Tricoat			
Ausfuehrung							- / + mm						
Anpressdr.	Silber	Tricoat	Silber	Tricoat									
Exenter					 i.S. ZA								
f. E-Oeffner													

Schliessteile fuer Z-TF			Fallenschließteil ZT-F	MF-BO f. Z-TF				
Anpressdr.	Silber	Tricoat			Silber	Tricoat		
				rechts				
Excenter				links				
f. E-Oeffner								
Schliessteile fuer Z-TS			TB-Schliessteil	Schliessteile fuer Z-TS			HO-BO ZA	
	Silber	Tricoat		Anpressdr.	Silber	Tricoat		
Rechts								
Links				- / + mm				
Schliessteile fuer Z-TS			HO-BO U	Riegelschliessteil f. 2-flg. Haustueren ZA (Z-TS, Z-TF,G-TS)				
Anpressdr.	Silber	Tricoat		Anpressdr.	Silber	Tricoat		
- / + mm				- / + mm				
Schliessteile fuer G-TS			Hakenschliesst. U-Profil	Schliessteile fuer G-TS			Hakenschliessteil ZA	
Anpressdr.	Silber	Tricoat		Anpressdr.	Silber	Tricoat		
- / + mm				- / + mm				
Schliessteile fuer G-TS			Bolzenschliesst. U-Profil	Schliessteile fuer G-TS			Bolzenschliessteil ZA	
Anpressdr.	Silber	Tricoat		Anpressdr.	Silber	Tricoat		
- / + mm				- / + mm				
Fraesabdeckungen f. Schließteile		Schwarz	Verarbeitungshinweise					
Bolzen								
Haken + Zusatzschloss								
Riegelschliessteil								
HO BO								
Fallen - u. Riegelschliessteil								

Rechtsansprüche aus der Anwendung der in diesem Profilblatt angegebenen Artikel können nicht geltend gemacht werden. Dieses Profilblatt ersetzt keine Pruefung in einem akkreditiertem Pruefinstitut !

KOE12T
KÖMMERLING
EuroFutur AD_PROTECT









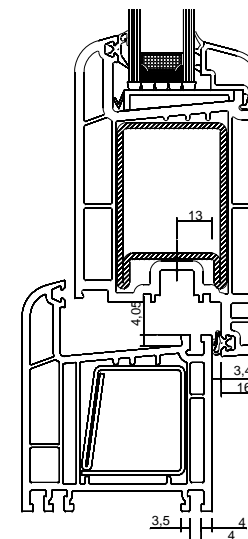



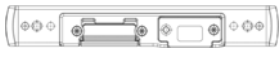
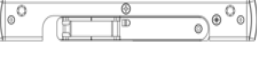

Rahmen

Fluegel

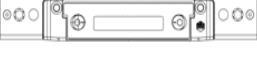
Falzluft mm: Ueberschlag mm: Versatz mm:



Schliessteilleisten U-Profil													
Schloss	Silber	Tricoat	Silber	Tricoat	Silber	Tricoat	Silber	Tricoat	Silber	Tricoat	Silber	Tricoat	
Fuer Z-TF	2MF + 2iS		2MF + 2iS K+500		2MF + 3iS K+1030		2MF + 4iS		2MF + 4iS K+500		2MF-BO		
rechts	210734		213708		213710		213712		213714		215604		
links	210735		213709		213711		213713		213715		215605		
Fuer Z-TF	2MF-BO K+605		2MF-BO K+980		Fuer Z-TS		2 HO-BO + ZS		4 HO-BO				
rechts	215606		215608		rechts				213666				
links	215607		215609		links				213667				
Fuer Z-TS	3 iS + TB		2 HO-BO + TB		4 iS		3iS + ZS		2 HO-BO		2 HO-BO + 2iS		
rechts	214349		214363		208562		208556		211638				
links	214350		214364		208561		208555		211639				
Fuer G-TS	4 iS		2 BO		2 BO+ZS								
rechts	208562		208558		208554								
links	208561		208557		208553								
Schliessteile fuer Z-TS, Z-TF, G-TS					i.S. U-Profil 		Rechts		Links				
Fallen- u Riegelschliessteile							Silber	Tricoat	Silber	Tricoat			
Ausfuehrung	U-6x32x9						207144		207145				
	Rechts		Links		- / + mm								
Anpressdr.	Silber	Tricoat	Silber	Tricoat									
	209144		209145										
Exenter	209141		209142										
f. E-Oeffner					i.S. ZA 		355497		355509				
					- / + mm								

Schliessteile fuer Z-TF			Fallenschließteil ZT-F	MF-BO f. Z-TF				
Anpressdr.	Silber	Tricoat			Silber	Tricoat		
	209986			rechts	215602			
Excenter	209143			links	215603			
f. E-Oeffner								
Schliessteile fuer Z-TS			TB-Schliessteil	Schliessteile fuer Z-TS			HO-BO ZA	
	Silber	Tricoat		Anpressdr.	Silber	Tricoat		
Rechts	214377				211552			
Links	214378			- / + mm				
Schliessteile fuer Z-TS			HO-BO U	Riegelschliessteil f. 2-flg. Haustueren ZA (Z-TS, Z-TF,G-TS)				
Anpressdr.	Silber	Tricoat		Anpressdr.	Silber	Tricoat		
					206926			
- / + mm				- / + mm				
Schliessteile fuer G-TS			Hakenschliesst. U-Profil	Schliessteile fuer G-TS			Hakenschliessteil ZA	
Anpressdr.	Silber	Tricoat		Anpressdr.	Silber	Tricoat		
	207142				204081			
- / + mm				- / + mm				
Schliessteile fuer G-TS			Bolzenschliesst. U-Profil	Schliessteile fuer G-TS			Bolzenschliessteil ZA	
Anpressdr.	Silber	Tricoat		Anpressdr.	Silber	Tricoat		
	207143				204071			
- / + mm				- / + mm				
Fraesabdeckungen f. Schließteile		Schwarz	Verarbeitungshinweise					
Bolzen		355399	Hook Strike APD -1mm					
Haken + Zusatzschloss		355401						
Riegelschliessteil		355403						
HO BO		358027						
Fallen - u. Riegelschliessteil								

Rechtsansprüche aus der Anwendung der in diesem Profilblatt angegebenen Artikel können nicht geltend gemacht werden. Dieses Profilblatt ersetzt keine Pruefung in einem akkreditiertem Pruefinstitut !

KOE11T
KÖMMERLING



EuroFutur MD Classic/Exklusiv_PROTECT







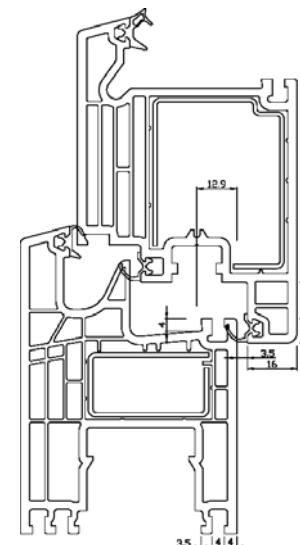

Rahmen 2606, 2608;

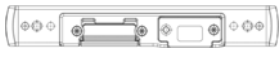
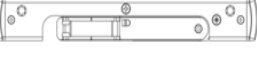
Fluegel 2618

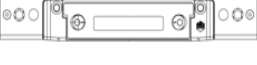
Falzluft mm: 12 Ueberschlag mm: 20 Versatz mm: 13



Schliessteilleisten U-Profil													
Schloss	Silber	Tricoat	Silber	Tricoat	Silber	Tricoat	Silber	Tricoat	Silber	Tricoat	Silber	Tricoat	
Fuer Z-TF	2MF + 2iS		2MF + 2iS K+500		2MF + 3iS K+1030		2MF + 4iS		2MF + 4iS K+500		2MF-BO		
rechts	210734		213708		213710		213712		213714		215604		
links	210735		213709		213711		213713		213715		215605		
Fuer Z-TF	2MF-BO K+605		2MF-BO K+980		Fuer Z-TS		2 HO-BO + ZS		4 HO-BO				
rechts	215606		215608		rechts				213666				
links	215607		215609		links				213667				
Fuer Z-TS	3 iS + TB		2 HO-BO + TB		4 iS		3iS + ZS		2 HO-BO		2 HO-BO + 2iS		
rechts	214349		214363						211638				
links	214350		214364						211639				
Fuer G-TS	4 iS		2 BO		2 BO+ZS								
rechts													
links													
Schliessteile fuer Z-TS, Z-TF, G-TS					i.S. U-Profil			Rechts		Links			
Fallen- u Riegelschliessteile								Silber		Tricoat		Silber	
Ausfuehrung					U-6x32x9								
		Rechts		Links									
Anpressdr.	Silber	Tricoat	Silber	Tricoat									
	209144		209145										
Exenter	209141		209142										
f. E-Oeffner													
					i.S. ZA			355497		355509			

Schliessteile fuer Z-TF			Fallenschließteil ZT-F	MF-BO f. Z-TF				
Anpressdr.	Silber	Tricoat			Silber	Tricoat		
	209986			rechts	215602			
Excenter	209143			links	215603			
f. E-Oeffner								
Schliessteile fuer Z-TS			TB-Schliessteil	Schliessteile fuer Z-TS			HO-BO ZA	
	Silber	Tricoat		Anpressdr.	Silber	Tricoat		
Rechts	214377				211552			
Links	214378			- / + mm				
Schliessteile fuer Z-TS			HO-BO U	Riegelschliessteil f. 2-flg. Haustueren ZA (Z-TS, Z-TF,G-TS)				
Anpressdr.	Silber	Tricoat		Anpressdr.	Silber	Tricoat		
					206926			
- / + mm				- / + mm				
Schliessteile fuer G-TS			Hakenschliesst. U-Profil	Schliessteile fuer G-TS			Hakenschliessteil ZA	
Anpressdr.	Silber	Tricoat		Anpressdr.	Silber	Tricoat		
					204081			
- / + mm				- / + mm				
Schliessteile fuer G-TS			Bolzenschliesst. U-Profil	Schliessteile fuer G-TS			Bolzenschliessteil ZA	
Anpressdr.	Silber	Tricoat		Anpressdr.	Silber	Tricoat		
					204071			
- / + mm				- / + mm				
Fraesabdeckungen f. Schließteile		Schwarz	Verarbeitungshinweise					
Bolzen		355399	Hook Strike APD -1mm					
Haken + Zusatzschloss		355401						
Riegelschliessteil		355403						
HO BO		358027						
Fallen - u. Riegelschliessteil								

Rechtsansprüche aus der Anwendung der in diesem Profilblatt angegebenen Artikel können nicht geltend gemacht werden. Dieses Profilblatt ersetzt keine Pruefung in einem akkreditiertem Pruefinstitut !

KOE17T
KÖMMERLING



System 88+ MD PROTECT







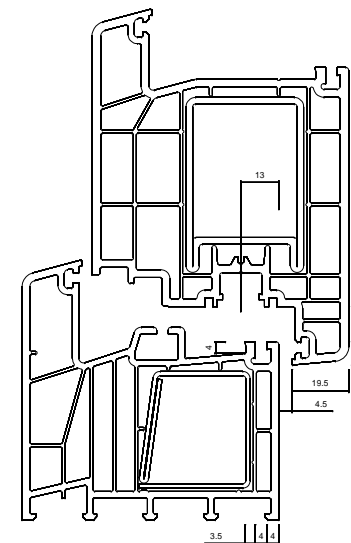

Rahmen 6201,6202;

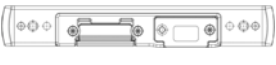
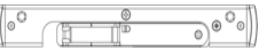
Fluegel 6216,6215;

Falzlufth mm: 12 Ueberschlag mm: 20 Versatz mm: 13



Schliessteilleisten U-Profil												
Schloss	Silber	Tricoat	Silber	Tricoat	Silber	Tricoat	Silber	Tricoat	Silber	Tricoat	Silber	Tricoat
Fuer Z-TF	2MF + 2iS		2MF + 2iS K+500		2MF + 3iS K+1030		2MF + 4iS		2MF + 4iS K+500		2MF-BO	
rechts	213923		213927		213925		213931				216910	
links	213924		213928		213926		213932				216911	
Fuer Z-TF	2MF-BO K+605		2MF-BO K+980		Fuer Z-TS		2 HO-BO + ZS		4 HO-BO			
rechts	216914		216912		rechts							
links	216915		216913		links							
Fuer Z-TS	3 iS + TB		2 HO-BO + TB		4 iS		3iS + ZS		2 HO-BO		2 HO-BO + 2iS	
rechts					208609				213933			
links					208610				213934			
Fuer G-TS	4 iS		2 BO		2 BO+ZS							
rechts	208609											
links	208610											
Schliessteile fuer Z-TS, Z-TF, G-TS					i.S. U-Profil			Rechts		Links		
Fallen- u Riegelschliessteile								Silber		Tricoat		Silber
Ausfuehrung					U-6x24x6							
		Rechts		Links								
Anpressdr.	Silber	Tricoat	Silber	Tricoat								
	215199		215204									
Exenter												
f. E-Oeffner	215199		215204									
					i.S. ZA			355497		355509		

Schliessteile fuer Z-TF			Fallenschließteil ZT-F	MF-BO f. Z-TF				
Anpressdr.	Silber	Tricoat			Silber	Tricoat		
	215499			rechts	216908			
Excenter				links	216908			
f. E-Oeffner	215499							
Schliessteile fuer Z-TS			TB-Schliessteil	Schliessteile fuer Z-TS			HO-BO ZA	
	Silber	Tricoat		Anpressdr.	Silber	Tricoat		
Rechts					211552			
Links				- / + mm	216535			-1
Schliessteile fuer Z-TS			HO-BO U	Riegelschliessteil f. 2-flg. Haustueren ZA (Z-TS, Z-TF,G-TS)				
Anpressdr.	Silber	Tricoat		Anpressdr.	Silber	Tricoat		
					206926			
- / + mm				- / + mm				
Schliessteile fuer G-TS			Hakenschliesst. U-Profil	Schliessteile fuer G-TS			Hakenschliessteil ZA	
Anpressdr.	Silber	Tricoat		Anpressdr.	Silber	Tricoat		
					204081			
- / + mm				- / + mm				
Schliessteile fuer G-TS			Bolzenschliesst. U-Profil	Schliessteile fuer G-TS			Bolzenschliessteil ZA	
Anpressdr.	Silber	Tricoat		Anpressdr.	Silber	Tricoat		
					204071			
- / + mm				- / + mm				
Fraesabdeckungen f. Schließteile		Schwarz	Verarbeitungshinweise					
Bolzen		355399	Schliessteil f. Falle- u. Riegel silber 212751 rechts, 212752 links sowie					
Haken + Zusatzschloss		355401	Fallenschliessteil Z-TF silber 212753 laufen aus !					
Riegelschliessteil		355403						
HO BO		358027						
Fallen - u. Riegelschliessteil								

Rechtsansprüche aus der Anwendung der in diesem Profilblatt angegebenen Artikel können nicht geltend gemacht werden. Dieses Profilblatt ersetzt keine Pruefung in einem akkreditiertem Pruefinstitut !

KOE18T
KÖMMERLING



K-Vision Trend aussendrehend







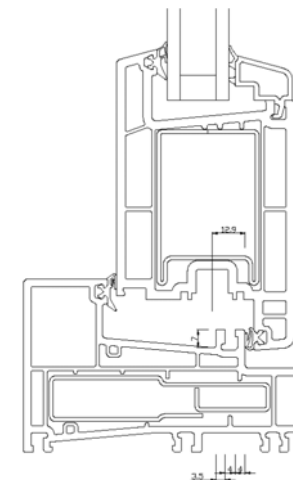

Rahmen 2495, 2487;

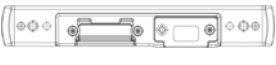
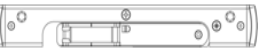
Fluegel 2415;

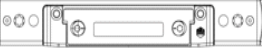
Falzluft mm: 12 Ueberschlag mm: 20 Versatz mm: 13



Schliessteilleisten U-Profil													
Schloss	Silber	Tricoat	Silber	Tricoat	Silber	Tricoat	Silber	Tricoat	Silber	Tricoat	Silber	Tricoat	
Fuer Z-TF	2MF + 2iS		2MF + 2iS K+500		2MF + 3iS K+1030		2MF + 4iS		2MF + 4iS K+500		2MF-BO		
rechts	216156		216158		216160		216162		216164		216168		
links	216157		216159		216161		216163		216165		216169		
Fuer Z-TF	2MF-BO K+605		2MF-BO K+980		Fuer Z-TS		2 HO-BO + ZS		4 HO-BO				
rechts	216170		216172		rechts								
links	216171		216173		links								
Fuer Z-TS	3 iS + TB		2 HO-BO + TB		4 iS		3iS + ZS		2 HO-BO		2 HO-BO + 2iS		
rechts			217103		216166				216154				
links			217105		216167				216155				
Fuer G-TS	4 iS		2 BO		2 BO+ZS								
rechts	216166												
links	216167												
Schliessteile fuer Z-TS, Z-TF, G-TS					i.S. U-Profil			Rechts		Links			
Fallen- u Riegelschliessteile								Silber		Tricoat		Silber	
Ausfuehrung					U-6x32x9								
		Rechts		Links			- / + mm						
Anpressdr.	Silber	Tricoat	Silber	Tricoat									
	216146		216147										
Exenter	216149		216150										
f. E-Oeffner					i.S. ZA			364211		364212			
							- / + mm						

Schliessteile fuer Z-TF			Fallenschließteil ZT-F	MF-BO f. Z-TF				
Anpressdr.	Silber	Tricoat			Silber	Tricoat		
	216148			rechts				
Excenter				links				
f. E-Oeffner								
Schliessteile fuer Z-TS			TB-Schliessteil	Schliessteile fuer Z-TS			HO-BO ZA	
	Silber	Tricoat		Anpressdr.	Silber	Tricoat		
Rechts					216152			
Links				- / + mm				
Schliessteile fuer Z-TS			HO-BO U	Riegelschliessteil f. 2-flg. Haustueren ZA (Z-TS, Z-TF,G-TS)				
Anpressdr.	Silber	Tricoat		Anpressdr.	Silber	Tricoat		
					216151			
- / + mm				- / + mm				
Schliessteile fuer G-TS			Hakenschliesst. U-Profil	Schliessteile fuer G-TS			Hakenschliessteil ZA	
Anpressdr.	Silber	Tricoat		Anpressdr.	Silber	Tricoat		
				- / + mm				
- / + mm								
Schliessteile fuer G-TS			Bolzenschliesst. U-Profil	Schliessteile fuer G-TS			Bolzenschliessteil ZA	
Anpressdr.	Silber	Tricoat		Anpressdr.	Silber	Tricoat		
				- / + mm				
- / + mm								
Fraesabdeckungen f. Schließteile		Schwarz	Verarbeitungshinweise					
Bolzen		355399						
Haken + Zusatzschloss		355401						
Riegelschliessteil		355403						
HO BO		358027						
Fallen - u. Riegelschliessteil								

Rechtsansprüche aus der Anwendung der in diesem Profilblatt angegebenen Artikel können nicht geltend gemacht werden. Dieses Profilblatt ersetzt keine Pruefung in einem akkreditiertem Pruefinstitut !

KOE13T
KÖMMERLING
GOLD 70_PROTECT





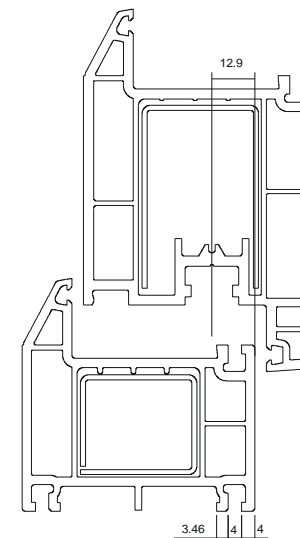

Rahmen

Fluegel

Falzluft mm: Ueberschlag mm: Versatz mm:



Schliessteilleisten U-Profil 												
Schloss	Silber	Tricoat	Silber	Tricoat	Silber	Tricoat	Silber	Tricoat	Silber	Tricoat	Silber	Tricoat
Fuer Z-TF	2MF + 2iS		2MF + 2iS K+500		2MF + 3iS K+1030		2MF + 4iS		2MF + 4iS K+500		2MF-BO	
rechts	210744		213839		213841		213843		213845			
links	210745		213840		213842		213844		213846			
Fuer Z-TF	2MF-BO K+605		2MF-BO K+980		Fuer Z-TS		2 HO-BO + ZS		4 HO-BO			
rechts					rechts		213803					
links					links		213804					
Fuer Z-TS	3 iS + TB		2 HO-BO + TB		4 iS		3iS + ZS		2 HO-BO		2 HO-BO + 2iS	
rechts					213797		213799		213801			
links					213798		213800		213802			
Fuer G-TS	4 iS		2 BO		2 BO+ZS							
rechts	213797											
links	213798											
Schliessteile fuer Z-TS, Z-TF, G-TS					i.S. U-Profil 		Rechts		Links			
Fallen- u Riegelschliessteile							Silber	Tricoat	Silber	Tricoat		
Ausfuehrung	U-6x32x9				207176		207177					
		Rechts		Links		- / + mm						
Anpressdr.	Silber	Tricoat	Silber	Tricoat								
	209139		209140									
Exenter	209136		209137									
f. E-Oeffner						i.S. ZA 		355023		355048		
						- / + mm						

Schliessteile fuer Z-TF			Fallenschließteil ZT-F	MF-BO f. Z-TF				
Anpressdr.	Silber	Tricoat			Silber	Tricoat		
	209987			rechts				
Excenter	209138			links				
f. E-Oeffner								
Schliessteile fuer Z-TS			TB-Schliessteil	Schliessteile fuer Z-TS			HO-BO ZA	
	Silber	Tricoat		Anpressdr.	Silber	Tricoat		
Rechts	215432				211551			
Links	215433			- / + mm				
Schliessteile fuer Z-TS			HO-BO U	Riegelschliessteil f. 2-flg. Haustueren ZA (Z-TS, Z-TF,G-TS)				
Anpressdr.	Silber	Tricoat		Anpressdr.	Silber	Tricoat		
					206933			
- / + mm				- / + mm				
Schliessteile fuer G-TS			Hakenschliesst. U-Profil	Schliessteile fuer G-TS			Hakenschliessteil ZA	
Anpressdr.	Silber	Tricoat		Anpressdr.	Silber	Tricoat		
	207174				203572			
- / + mm				- / + mm				
Schliessteile fuer G-TS			Bolzenschliesst. U-Profil	Schliessteile fuer G-TS			Bolzenschliessteil ZA	
Anpressdr.	Silber	Tricoat		Anpressdr.	Silber	Tricoat		
	207175				203597			
- / + mm				- / + mm				
Fraesabdeckungen f. Schließteile		Schwarz	Verarbeitungshinweise					
Bolzen		355399						
Haken + Zusatzschloss		355401						
Riegelschliessteil		355403						
HO BO		358027						
Fallen - u. Riegelschliessteil								

Rechtsansprüche aus der Anwendung der in diesem Profilblatt angegebenen Artikel können nicht geltend gemacht werden. Dieses Profilblatt ersetzt keine Pruefung in einem akkreditiertem Pruefinstitut !













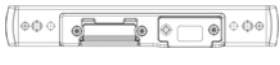
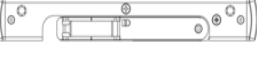

Eurodur 3S_PROTECT

Rahmen 1400, 1401, 1402, 1407, 1405, 1408, 1406, 1421, 1422, 1423

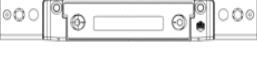
Fluegel 1410-1416

Falzluft mm: 12 Ueberschlag mm: 19 Versatz mm: 13

Schliessteilleisten U-Profil 												
Schloss	Silber	Tricoat	Silber	Tricoat	Silber	Tricoat	Silber	Tricoat	Silber	Tricoat	Silber	Tricoat
Fuer Z-TF	2MF + 2iS		2MF + 2iS K+500		2MF + 3iS K+1030		2MF + 4iS		2MF + 4iS K+500		2MF-BO	
rechts	210734		213708		213710		213712		213714		215604	
links	210735		213709		213711		213713		213715		215605	
Fuer Z-TF	2MF-BO K+605		2MF-BO K+980		Fuer Z-TS		2 HO-BO + ZS		4 HO-BO			
rechts	215606		215608		rechts				213666			
links	215607		215609		links				213667			
Fuer Z-TS	3 iS + TB		2 HO-BO + TB		4 iS		3iS + ZS		2 HO-BO		2 HO-BO + 2iS	
rechts	214349		214363		208562		208556		211638			
links	214350		214364		208561		208555		211639			
Fuer G-TS	4 iS		2 BO		2 BO+ZS							
rechts	208562		208558		208554							
links	208561		208557		208553							
Schliessteile fuer Z-TS, Z-TF, G-TS					i.S. U-Profil 			Rechts		Links		
Fallen- u Riegelschliessteile								Silber	Tricoat	Silber	Tricoat	
Ausfuehrung					U-6x32x9			207144		207145		
		Rechts		Links		- / + mm						
Anpressdr.	Silber	Tricoat	Silber	Tricoat								
	209144		209145									
Exenter	209141		209142									
f. E-Oeffner												
					i.S. ZA 			355497		355509		
								- / + mm				

Schliessteile fuer Z-TF			Fallenschließteil ZT-F	MF-BO f. Z-TF				
Anpressdr.	Silber	Tricoat			Silber	Tricoat		
	209986			rechts	215602			
Excenter	209143			links	215603			
f. E-Oeffner								
Schliessteile fuer Z-TS			TB-Schliessteil	Schliessteile fuer Z-TS			HO-BO ZA	
	Silber	Tricoat		Anpressdr.	Silber	Tricoat		
Rechts	214377				211552			
Links	214378			- / + mm				
Schliessteile fuer Z-TS			HO-BO U	Riegelschliessteil f. 2-flg. Haustueren ZA (Z-TS, Z-TF,G-TS)				
Anpressdr.	Silber	Tricoat		Anpressdr.	Silber	Tricoat		
					206926			
- / + mm				- / + mm				
Schliessteile fuer G-TS			Hakenschliesst. U-Profil	Schliessteile fuer G-TS			Hakenschliessteil ZA	
Anpressdr.	Silber	Tricoat		Anpressdr.	Silber	Tricoat		
	207142				204081			
- / + mm				- / + mm				
Schliessteile fuer G-TS			Bolzenschliesst. U-Profil	Schliessteile fuer G-TS			Bolzenschliessteil ZA	
Anpressdr.	Silber	Tricoat		Anpressdr.	Silber	Tricoat		
	207143				204071			
- / + mm				- / + mm				
Fraesabdeckungen f. Schließteile		Schwarz	Verarbeitungshinweise					
Bolzen		355399						
Haken + Zusatzschloss		355401						
Riegelschliessteil		355403						
HO BO		358027						
Fallen - u. Riegelschliessteil								

Rechtsansprüche aus der Anwendung der in diesem Profilblatt angegebenen Artikel können nicht geltend gemacht werden. Dieses Profilblatt ersetzt keine Pruefung in einem akkreditiertem Pruefinstitut !

PR10T
PROFIALIS













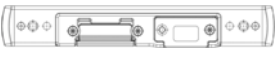
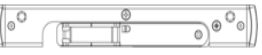

Performance

Rahmen

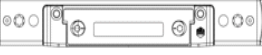
Fluegel





Falzluft mm: Ueberschlag mm: Versatz mm:







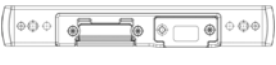
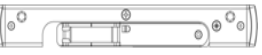

Schliessteilleisten U-Profil 												
Schloss	Silber	Tricoat	Silber	Tricoat	Silber	Tricoat	Silber	Tricoat	Silber	Tricoat	Silber	Tricoat
Fuer Z-TF	2MF + 2iS		2MF + 2iS K+500		2MF + 3iS K+1030		2MF + 4iS		2MF + 4iS K+500		2MF-BO	
rechts												
links												
Fuer Z-TF	2MF-BO K+605		2MF-BO K+980		Fuer Z-TS		2 HO-BO + ZS		4 HO-BO			
rechts					rechts							
links					links							
Fuer Z-TS	3 iS + TB		2 HO-BO + TB		4 iS		3iS + ZS		2 HO-BO		2 HO-BO + 2iS	
rechts												
links												
Fuer G-TS	4 iS		2 BO		2 BO+ZS							
rechts												
links												
Schliessteile fuer Z-TS, Z-TF, G-TS					i.S. U-Profil 			Rechts		Links		
Fallen- u Riegelschliessteile								Silber	Tricoat	Silber	Tricoat	
Ausfuehrung	U-6x32x9				217448		217449					
		Rechts		Links		- / + mm						
Anpressdr.	Silber	Tricoat	Silber	Tricoat								
					i.S. ZA 			365053		365054		
Exenter								- / + mm				
f. E-Oeffner	217443		217444									

Schliessteile fuer Z-TF			Fallenschließteil ZT-F	MF-BO f. Z-TF				
Anpressdr.	Silber	Tricoat			Silber	Tricoat		
				rechts				
Excenter				links				
f. E-Oeffner	217445							
Schliessteile fuer Z-TS			TB-Schliessteil	Schliessteile fuer Z-TS			HO-BO ZA	
	Silber	Tricoat		Anpressdr.	Silber	Tricoat		
Rechts					217446			
Links				- / + mm				
Schliessteile fuer Z-TS			HO-BO U	Riegelschliessteil f. 2-flg. Haustueren ZA (Z-TS, Z-TF,G-TS)				
Anpressdr.	Silber	Tricoat		Anpressdr.	Silber	Tricoat		
	217450							
- / + mm				- / + mm				
Schliessteile fuer G-TS			Hakenschliesst. U-Profil	Schliessteile fuer G-TS			Hakenschliessteil ZA	
Anpressdr.	Silber	Tricoat		Anpressdr.	Silber	Tricoat		
				- / + mm				
- / + mm								
Schliessteile fuer G-TS			Bolzenschliesst. U-Profil	Schliessteile fuer G-TS			Bolzenschliessteil ZA	
Anpressdr.	Silber	Tricoat		Anpressdr.	Silber	Tricoat		
				- / + mm				
- / + mm								
Fraesabdeckungen f. Schließteile		Schwarz	Verarbeitungshinweise					
Bolzen								
Haken + Zusatzschloss								
Riegelschliessteil								
HO BO								
Fallen - u. Riegelschliessteil								

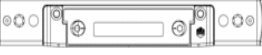
Rechtsansprüche aus der Anwendung der in diesem Profilblatt angegebenen Artikel können nicht geltend gemacht werden. Dieses Profilblatt ersetzt keine Pruefung in einem akkreditiertem Pruefinstitut !



Schliessteilleisten U-Profil 												
Schloss	Silber	Tricoat	Silber	Tricoat	Silber	Tricoat	Silber	Tricoat	Silber	Tricoat	Silber	Tricoat
Fuer Z-TF	2MF + 2iS		2MF + 2iS K+500		2MF + 3iS K+1030		2MF + 4iS		2MF + 4iS K+500		2MF-BO	
rechts												
links												
Fuer Z-TF	2MF-BO K+605		2MF-BO K+980		Fuer Z-TS		2 HO-BO + ZS		4 HO-BO			
rechts					rechts							
links					links							
Fuer Z-TS	3 iS + TB		2 HO-BO + TB		4 iS		3iS + ZS		2 HO-BO		2 HO-BO + 2iS	
rechts												
links												
Fuer G-TS	4 iS		2 BO		2 BO+ZS							
rechts												
links												
Schliessteile fuer Z-TS, Z-TF, G-TS					i.S. U-Profil 			Rechts		Links		
Fallen- u Riegelschliessteile								Silber	Tricoat	Silber	Tricoat	
Ausfuehrung											- / + mm	
		Rechts		Links								
Anpressdr.	Silber	Tricoat	Silber	Tricoat								
					i.S. ZA 							
Exenter								- / + mm				
f. E-Oeffner												

Schliessteile fuer Z-TF			Fallenschließteil ZT-F			MF-BO f. Z-TF				
Anpressdr.	Silber	Tricoat			Silber	Tricoat				
				rechts						
Excenter				links						
f. E-Oeffner										
Schliessteile fuer Z-TS			TB-Schliessteil			Schliessteile fuer Z-TS			HO-BO ZA	
	Silber	Tricoat		Anpressdr.	Silber	Tricoat				
Rechts										
Links				- / + mm						
Schliessteile fuer Z-TS			HO-BO U			Riegelschliessteil f. 2-flg. Haustueren ZA (Z-TS, Z-TF,G-TS)				
Anpressdr.	Silber	Tricoat		Anpressdr.	Silber	Tricoat				
- / + mm				- / + mm						
Schliessteile fuer G-TS			Hakenschliesst. U-Profil			Schliessteile fuer G-TS			Hakenschliessteil ZA	
Anpressdr.	Silber	Tricoat		Anpressdr.	Silber	Tricoat				
- / + mm				- / + mm						
Schliessteile fuer G-TS			Bolzenschliesst. U-Profil			Schliessteile fuer G-TS			Bolzenschliessteil ZA	
Anpressdr.	Silber	Tricoat		Anpressdr.	Silber	Tricoat				
- / + mm				- / + mm						
Fraesabdeckungen f. Schließteile		Schwarz	Verarbeitungshinweise							
Bolzen										
Haken + Zusatzschloss										
Riegelschliessteil										
HO BO										
Fallen - u. Riegelschliessteil										

Rechtsansprüche aus der Anwendung der in diesem Profilblatt angegebenen Artikel können nicht geltend gemacht werden. Dieses Profilblatt ersetzt keine Pruefung in einem akkreditiertem Pruefinstitut !

RE28T
REHAU







Edge IG 70mm Sculptured_Protect



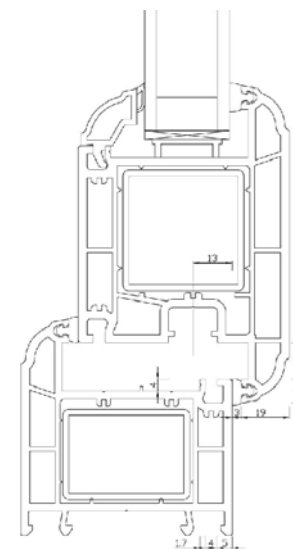



Rahmen 546655;

Fluegel 546725, 546715;

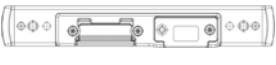
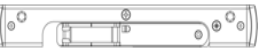
Falzluft mm: 12 Ueberschlag mm: 20 Versatz mm: 13

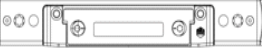

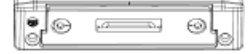
Schliessteilleisten U-Profil 												
Schloss	Silber	Tricoat	Silber	Tricoat	Silber	Tricoat	Silber	Tricoat	Silber	Tricoat	Silber	Tricoat
Fuer Z-TF	2MF + 2iS		2MF + 2iS K+500		2MF + 3iS K+1030		2MF + 4iS		2MF + 4iS K+500		2MF-BO	
rechts												
links												
Fuer Z-TF	2MF-BO K+605		2MF-BO K+980		Fuer Z-TS		2 HO-BO + ZS		4 HO-BO			
rechts					rechts							
links					links							
Fuer Z-TS	3 iS + TB		2 HO-BO + TB		4 iS		3iS + ZS		2 HO-BO		2 HO-BO + 2iS	
rechts												
links												
Fuer G-TS	4 iS		2 BO		2 BO+ZS							
rechts												
links												
Schliessteile fuer Z-TS, Z-TF, G-TS					i.S. U-Profil 			Rechts		Links		
Fallen- u Riegelschliessteile								Silber	Tricoat	Silber	Tricoat	
Ausfuehrung	U-6x32x9							- / + mm				
	Rechts		Links									
Anpressdr.	Silber	Tricoat	Silber	Tricoat								
	209164		209165									
Exenter												
f. E-Oeffner												
								- / + mm				

Schliessteile fuer Z-TF			Fallenschließteil ZT-F	MF-BO f. Z-TF				
Anpressdr.	Silber	Tricoat			Silber	Tricoat		
				rechts				
Excenter				links				
f. E-Oeffner								
Schliessteile fuer Z-TS			TB-Schliessteil	Schliessteile fuer Z-TS			HO-BO ZA	
	Silber	Tricoat		Anpressdr.	Silber	Tricoat		
Rechts								
Links				- / + mm				
Schliessteile fuer Z-TS			HO-BO U	Riegelschliessteil f. 2-flg. Haustueren ZA (Z-TS, Z-TF,G-TS)				
Anpressdr.	Silber	Tricoat		Anpressdr.	Silber	Tricoat		
					212579			
- / + mm				- / + mm				
Schliessteile fuer G-TS			Hakenschliesst. U-Profil	Schliessteile fuer G-TS			Hakenschliessteil ZA	
Anpressdr.	Silber	Tricoat		Anpressdr.	Silber	Tricoat		
					212294			
- / + mm				- / + mm				
Schliessteile fuer G-TS			Bolzenschliesst. U-Profil	Schliessteile fuer G-TS			Bolzenschliessteil ZA	
Anpressdr.	Silber	Tricoat		Anpressdr.	Silber	Tricoat		
- / + mm				- / + mm				
Fraesabdeckungen f. Schließteile		Schwarz	Verarbeitungshinweise					
Bolzen			212294 Hook strike UK silver					
Haken + Zusatzschloss			212579 Dooble slot strike UK silver					
Riegelschliessteil			Latchplate without dust box: 211867 (216085 -2mm APD) right, 211868 (216086					
HO BO			Hook striker Uk without dust box: 212575 silver					
Fallen - u. Riegelschliessteil			Latchplate allan key adjuster without dust box -2mm APD: 217340 right, 217341					

Rechtsansprüche aus der Anwendung der in diesem Profilblatt angegebenen Artikel können nicht geltend gemacht werden. Dieses Profilblatt ersetzt keine Pruefung in einem akkreditiertem Pruefinstitut !

RE29T
REHAU







S706 13mm non IG_PROTECT



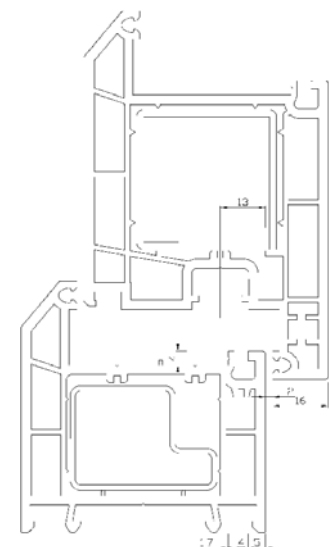



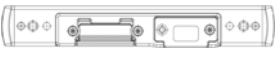
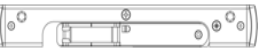

Rahmen

Fluegel

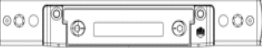
Falzlufthöhe mm: Ueberschlag mm: Versatz mm:



Schliessteilleisten U-Profil 												
Schloss	Silber	Tricoat	Silber	Tricoat	Silber	Tricoat	Silber	Tricoat	Silber	Tricoat	Silber	Tricoat
Fuer Z-TF	2MF + 2iS		2MF + 2iS K+500		2MF + 3iS K+1030		2MF + 4iS		2MF + 4iS K+500		2MF-BO	
rechts												
links												
Fuer Z-TF	2MF-BO K+605		2MF-BO K+980		Fuer Z-TS		2 HO-BO + ZS		4 HO-BO			
rechts					rechts							
links					links							
Fuer Z-TS	3 iS + TB		2 HO-BO + TB		4 iS		3iS + ZS		2 HO-BO		2 HO-BO + 2iS	
rechts												
links												
Fuer G-TS	4 iS		2 BO		2 BO+ZS							
rechts												
links												
Schliessteile fuer Z-TS, Z-TF, G-TS					i.S. U-Profil 			Rechts		Links		
Fallen- u Riegelschliessteile								Silber	Tricoat	Silber	Tricoat	
Ausfuehrung					- / + mm							
		Rechts		Links								
Anpressdr.	Silber	Tricoat	Silber	Tricoat								
	209154		209155									
i.S. ZA 					- / + mm							
Exenter												
f. E-Oeffner												

Schliessteile fuer Z-TF			Fallenschließteil ZT-F			MF-BO f. Z-TF					
Anpressdr.	Silber	Tricoat			Silber	Tricoat					
				rechts							
Excenter				links							
f. E-Oeffner											
Schliessteile fuer Z-TS			TB-Schliessteil			Schliessteile fuer Z-TS			HO-BO ZA		
	Silber	Tricoat		Anpressdr.	Silber	Tricoat					
Rechts											
Links				- / + mm							
Schliessteile fuer Z-TS			HO-BO U			Riegelschliessteil f. 2-flg. Haustueren ZA (Z-TS, Z-TF,G-TS)					
Anpressdr.	Silber	Tricoat		Anpressdr.	Silber	Tricoat					
- / + mm				- / + mm							
Schliessteile fuer G-TS			Hakenschliesst. U-Profil			Schliessteile fuer G-TS			Hakenschliessteil ZA		
Anpressdr.	Silber	Tricoat		Anpressdr.	Silber	Tricoat					
- / + mm				- / + mm							
Schliessteile fuer G-TS			Bolzenschliesst. U-Profil			Schliessteile fuer G-TS			Bolzenschliessteil ZA		
Anpressdr.	Silber	Tricoat		Anpressdr.	Silber	Tricoat					
- / + mm				- / + mm							
Fraesabdeckungen f. Schließteile		Schwarz	Verarbeitungshinweise								
Bolzen											
Haken + Zusatzschloss											
Riegelschliessteil											
HO BO											
Fallen - u. Riegelschliessteil											

Rechtsansprüche aus der Anwendung der in diesem Profilblatt angegebenen Artikel können nicht geltend gemacht werden. Dieses Profilblatt ersetzt keine Pruefung in einem akkreditiertem Pruefinstitut !

RE27T
REHAU



NL aussen oeffnend







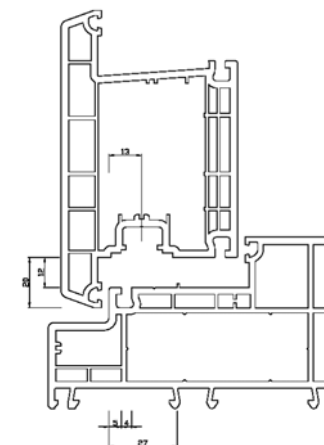

Rahmen 550039, 550049;

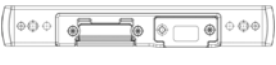
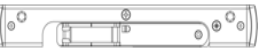
Fluegel 550170;

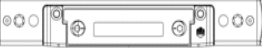
Falzluft mm: 12 Ueberschlag mm: 20 Versatz mm: 13



Schliessteilleisten U-Profil												
Schloss	Silber	Tricoat	Silber	Tricoat	Silber	Tricoat	Silber	Tricoat	Silber	Tricoat	Silber	Tricoat
Fuer Z-TF	2MF + 2iS		2MF + 2iS K+500		2MF + 3iS K+1030		2MF + 4iS		2MF + 4iS K+500		2MF-BO	
rechts	216229		216231		216233		216235		216237		216239	
links	216230		216232		216234		216236		216238		216240	
Fuer Z-TF	2MF-BO K+605		2MF-BO K+980		Fuer Z-TS		2 HO-BO + ZS		4 HO-BO			
rechts	216241		216243		rechts							
links	216242		216244		links							
Fuer Z-TS	3 iS + TB		2 HO-BO + TB		4 iS		3iS + ZS		2 HO-BO		2 HO-BO + 2iS	
rechts					216245				216227			
links					216246				216228			
Fuer G-TS	4 iS		2 BO		2 BO+ZS							
rechts	216245											
links	216246											
Schliessteile fuer Z-TS, Z-TF, G-TS					i.S. U-Profil			Rechts		Links		
Fallen- u Riegelschliessteile								Silber		Tricoat		Silber
Ausfuehrung					U-6x24x6							
		Rechts		Links								
Anpressdr.	Silber	Tricoat	Silber	Tricoat								
	216221		216222									
Exenter												
f. E-Oeffner	216221		216222									
					i.S. ZA			364263		364264		

Schliessteile fuer Z-TF			Fallenschließteil ZT-F	MF-BO f. Z-TF				
Anpressdr.	Silber	Tricoat			Silber	Tricoat		
	216225			rechts				
Excenter				links				
f. E-Oeffner	216225							
Schliessteile fuer Z-TS			TB-Schliessteil	Schliessteile fuer Z-TS			HO-BO ZA	
	Silber	Tricoat		Anpressdr.	Silber	Tricoat		
Rechts					216226			
Links				- / + mm				
Schliessteile fuer Z-TS			HO-BO U	Riegelschliessteil f. 2-flg. Haustueren ZA (Z-TS, Z-TF,G-TS)				
Anpressdr.	Silber	Tricoat		Anpressdr.	Silber	Tricoat		
					216248			
- / + mm				- / + mm				
Schliessteile fuer G-TS			Hakenschliesst. U-Profil	Schliessteile fuer G-TS			Hakenschliessteil ZA	
Anpressdr.	Silber	Tricoat		Anpressdr.	Silber	Tricoat		
				- / + mm				
- / + mm								
Schliessteile fuer G-TS			Bolzenschliesst. U-Profil	Schliessteile fuer G-TS			Bolzenschliessteil ZA	
Anpressdr.	Silber	Tricoat		Anpressdr.	Silber	Tricoat		
				- / + mm				
- / + mm								
Fraesabdeckungen f. Schließteile		Schwarz	Verarbeitungshinweise					
Bolzen			216247 Riegelschliessteil 2 Schlitze silber f. Bodenschwelle					
Haken + Zusatzschloss			216221, 216222, 216225 f. E-Oeffner eff 118.13A71 Profix2					
Riegelschliessteil								
HO BO								
Fallen - u. Riegelschliessteil								

Rechtsansprüche aus der Anwendung der in diesem Profilblatt angegebenen Artikel können nicht geltend gemacht werden. Dieses Profilblatt ersetzt keine Pruefung in einem akkreditiertem Pruefinstitut !







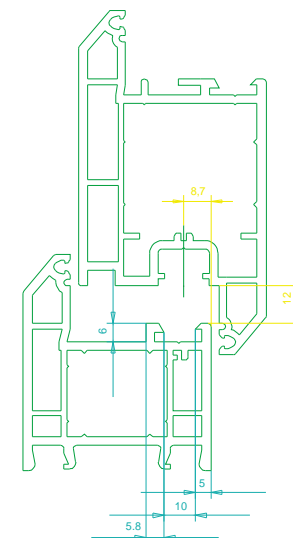

RE01T
REHAU
S 702_PROTECT

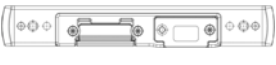
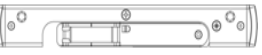

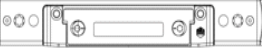
Rahmen
 Fluegel
 Falzluft mm: Ueberschlag mm: Versatz mm:



Schliessteilleisten U-Profil												
Schloss	Silber	Tricoat	Silber	Tricoat	Silber	Tricoat	Silber	Tricoat	Silber	Tricoat	Silber	Tricoat
Fuer Z-TF	2MF + 2iS		2MF + 2iS K+500		2MF + 3iS K+1030		2MF + 4iS		2MF + 4iS K+500		2MF-BO	
rechts												
links												
Fuer Z-TF	2MF-BO K+605		2MF-BO K+980		Fuer Z-TS		2 HO-BO + ZS		4 HO-BO			
rechts					rechts							
links					links							
Fuer Z-TS	3 iS + TB		2 HO-BO + TB		4 iS		3iS + ZS		2 HO-BO		2 HO-BO + 2iS	
rechts												
links												
Fuer G-TS	4 iS		2 BO		2 BO+ZS							
rechts												
links												
Schliessteile fuer Z-TS, Z-TF, G-TS					i.S. U-Profil			Rechts		Links		
Fallen- u Riegelschliessteile								Silber		Tricoat		Silber
Ausfuehrung		U-6x32x9										
		Rechts		Links								
Anpressdr.		Silber	Tricoat	Silber	Tricoat							
		209149		209150								
Exenter		206146		206147								
f. E-Oeffner								355492		355504		

Schliessteile fuer Z-TF			Fallenschließteil ZT-F		MF-BO f. Z-TF				
Anpressdr.	Silber	Tricoat				Silber	Tricoat		
					rechts				
Excenter	209148				links				
f. E-Oeffner									
Schliessteile fuer Z-TS			TB-Schliessteil		Schliessteile fuer Z-TS			HO-BO ZA	
	Silber	Tricoat			Anpressdr.	Silber	Tricoat		
Rechts									
Links					- / + mm				
Schliessteile fuer Z-TS			HO-BO U		Riegelschliessteil f. 2-flg. Haustueren ZA (Z-TS, Z-TF,G-TS)				
Anpressdr.	Silber	Tricoat			Anpressdr.	Silber	Tricoat		
						206918			
- / + mm					- / + mm				
Schliessteile fuer G-TS			Hakenschliesst. U-Profil		Schliessteile fuer G-TS			Hakenschliessteil ZA	
Anpressdr.	Silber	Tricoat			Anpressdr.	Silber	Tricoat		
						204076			
- / + mm					- / + mm				
Schliessteile fuer G-TS			Bolzenschliesst. U-Profil		Schliessteile fuer G-TS			Bolzenschliessteil ZA	
Anpressdr.	Silber	Tricoat			Anpressdr.	Silber	Tricoat		
						204066			
- / + mm					- / + mm				
Fraesabdeckungen f. Schließteile		Schwarz	Verarbeitungshinweise						
Bolzen		355400							
Haken + Zusatzschloss		355402							
Riegelschliessteil		355404							
HO BO									
Fallen - u. Riegelschliessteil									

Rechtsansprüche aus der Anwendung der in diesem Profilblatt angegebenen Artikel können nicht geltend gemacht werden. Dieses Profilblatt ersetzt keine Pruefung in einem akkreditiertem Pruefinstitut !

RE31T
REHAU







Geneo Haustür mit Armierung



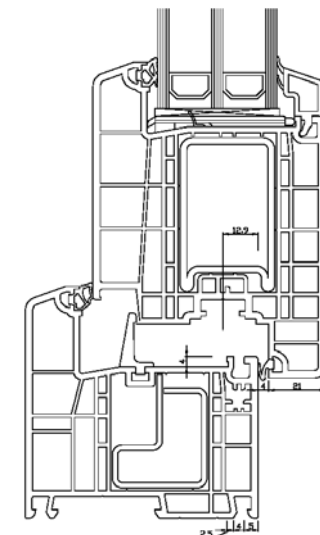



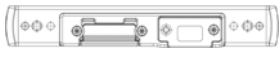
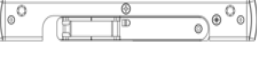

Rahmen

Fluegel

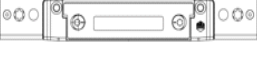
Falzlufth mm: Ueberschlag mm: Versatz mm:



Schliessteilleisten U-Profil 													
Schloss	Silber	Tricoat	Silber	Tricoat	Silber	Tricoat	Silber	Tricoat	Silber	Tricoat	Silber	Tricoat	
Fuer Z-TF	2MF + 2iS		2MF + 2iS K+500		2MF + 3iS K+1030		2MF + 4iS		2MF + 4iS K+500		2MF-BO		
rechts	213359				213365		213361		213363		216343		
links	213360				213366		213362		213364		216344		
Fuer Z-TF	2MF-BO K+605		2MF-BO K+980		Fuer Z-TS		2 HO-BO + ZS		4 HO-BO				
rechts	217963		217965		rechts				213355				
links	217964		217966		links				213356				
Fuer Z-TS	3 iS + TB		2 HO-BO + TB		4 iS		3iS + ZS		2 HO-BO		2 HO-BO + 2iS		
rechts					213357				213353				
links					213358				213354				
Fuer G-TS	4 iS		2 BO		2 BO+ZS								
rechts	213357												
links	213358												
Schliessteile fuer Z-TS, Z-TF, G-TS					i.S. U-Profil 			Rechts		Links			
Fallen- u Riegelschliessteile								Silber	Tricoat	Silber	Tricoat		
Ausfuehrung	U-6x32x9							207132		207133			
		Rechts		Links			- / + mm						
Anpressdr.	Silber	Tricoat	Silber	Tricoat									
	209164		209165					355490		355502			
Exenter	209161		209162					- / + mm					
f. E-Oeffner													

Schliessteile fuer Z-TF			Fallenschließteil ZT-F		MF-BO f. Z-TF				
Anpressdr.	Silber	Tricoat				Silber	Tricoat		
					rechts	217928			
Excenter	209163				links	217929			
f. E-Oeffner									
Schliessteile fuer Z-TS			TB-Schliessteil		Schliessteile fuer Z-TS			HO-BO ZA	
	Silber	Tricoat			Anpressdr.	Silber	Tricoat		
Rechts	216615								
Links	216616				- / + mm				
Schliessteile fuer Z-TS			HO-BO U		Riegelschliessteil f. 2-flg. Haustueren ZA (Z-TS, Z-TF,G-TS)				
Anpressdr.	Silber	Tricoat			Anpressdr.	Silber	Tricoat		
						206919			
- / + mm					- / + mm				
Schliessteile fuer G-TS			Hakenschliesst. U-Profil		Schliessteile fuer G-TS			Hakenschliessteil ZA	
Anpressdr.	Silber	Tricoat			Anpressdr.	Silber	Tricoat		
	207130					204074			
- / + mm					- / + mm				
Schliessteile fuer G-TS			Bolzenschliesst. U-Profil		Schliessteile fuer G-TS			Bolzenschliessteil ZA	
Anpressdr.	Silber	Tricoat			Anpressdr.	Silber	Tricoat		
	207131					204064			
- / + mm					- / + mm				
Fraesabdeckungen f. Schließteile		Schwarz	Verarbeitungshinweise						
Bolzen		355399							
Haken + Zusatzschloss		355401							
Riegelschliessteil		355403							
HO BO									
Fallen - u. Riegelschliessteil									

Rechtsansprüche aus der Anwendung der in diesem Profilblatt angegebenen Artikel können nicht geltend gemacht werden. Dieses Profilblatt ersetzt keine Pruefung in einem akkreditiertem Pruefinstitut !

RE22T
REHAU







Thermo Design Haustuere_PROTECT



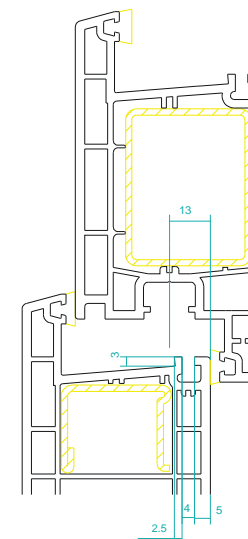



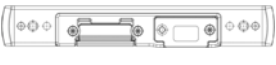
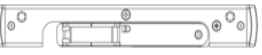

Rahmen

Fluegel

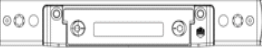
Falzluft mm: Ueberschlag mm: Versatz mm:



Schliessteilleisten U-Profil 												
Schloss	Silber	Tricoat	Silber	Tricoat	Silber	Tricoat	Silber	Tricoat	Silber	Tricoat	Silber	Tricoat
Fuer Z-TF	2MF + 2iS		2MF + 2iS K+500		2MF + 3iS K+1030		2MF + 4iS		2MF + 4iS K+500		2MF-BO	
rechts	210736		213716		213718		213720		213722		215596	
links	210737		213717		213719		213721		213723		215597	
Fuer Z-TF	2MF-BO K+605		2MF-BO K+980		Fuer Z-TS		2 HO-BO + ZS		4 HO-BO			
rechts	215598		215600		rechts				213668			
links	215599		215601		links				213669			
Fuer Z-TS	3 iS + TB		2 HO-BO + TB		4 iS		3iS + ZS		2 HO-BO		2 HO-BO + 2iS	
rechts	214345		214359		208574		208568		208599			
links	214346		214360		208573		208567		208600			
Fuer G-TS	4 iS		2 BO		2 BO+ZS							
rechts	208574		208570		208566							
links	208573		208569		208565							
Schliessteile fuer Z-TS, Z-TF, G-TS					i.S. U-Profil 			Rechts		Links		
Fallen- u Riegelschliessteile								Silber	Tricoat	Silber	Tricoat	
Ausfuehrung	U-6x32x9				207128		207129					
		Rechts		Links		- / + mm						
Anpressdr.	Silber	Tricoat	Silber	Tricoat								
	209159		209160									
Exenter	209156		209157									
f. E-Oeffner												
					i.S. ZA 			355489		355501		
								- / + mm				
								360606		360607		-2

Schliessteile fuer Z-TF			Fallenschließteil ZT-F	MF-BO f. Z-TF				
Anpressdr.	Silber	Tricoat			Silber	Tricoat		
	209988			rechts	215594			
Excenter	209158			links	215595			
f. E-Oeffner								
Schliessteile fuer Z-TS			TB-Schliessteil	Schliessteile fuer Z-TS			HO-BO ZA	
	Silber	Tricoat		Anpressdr.	Silber	Tricoat		
Rechts	214373				211553			
Links	214374			- / + mm	215094			-2
Schliessteile fuer Z-TS			HO-BO U	Riegelschliessteil f. 2-flg. Haustueren ZA (Z-TS, Z-TF,G-TS)				
Anpressdr.	Silber	Tricoat		Anpressdr.	Silber	Tricoat		
					206921			
- / + mm				- / + mm				
Schliessteile fuer G-TS			Hakenschliesst. U-Profil	Schliessteile fuer G-TS			Hakenschliessteil ZA	
Anpressdr.	Silber	Tricoat		Anpressdr.	Silber	Tricoat		
	207126				204073			
- / + mm				- / + mm				
Schliessteile fuer G-TS			Bolzenschliesst. U-Profil	Schliessteile fuer G-TS			Bolzenschliessteil ZA	
Anpressdr.	Silber	Tricoat		Anpressdr.	Silber	Tricoat		
	207127				204063			
- / + mm				- / + mm	215093			-2
Fraesabdeckungen f. Schließteile		Schwarz	Verarbeitungshinweise					
Bolzen		355399						
Haken + Zusatzschloss		355401						
Riegelschliessteil		355403						
HO BO		358027						
Fallen - u. Riegelschliessteil								

Rechtsansprüche aus der Anwendung der in diesem Profilblatt angegebenen Artikel können nicht geltend gemacht werden. Dieses Profilblatt ersetzt keine Pruefung in einem akkreditiertem Pruefinstitut !







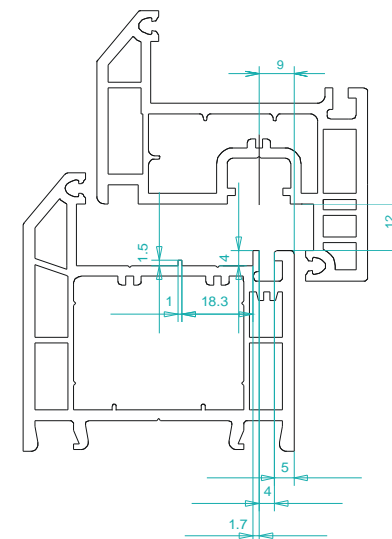

RE03T
REHAU
S 706 9V_PROTECT

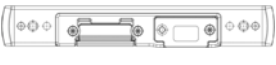
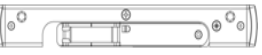

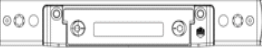
Rahmen	546108, 576430				
Fluegel	546210, 576460				
Falzlufth mm:	12	Ueberschlag mm:	22	Versatz mm:	9



Schliessteilleisten U-Profil												
Schloss	Silber	Tricoat	Silber	Tricoat	Silber	Tricoat	Silber	Tricoat	Silber	Tricoat	Silber	Tricoat
Fuer Z-TF	2MF + 2iS		2MF + 2iS K+500		2MF + 3iS K+1030		2MF + 4iS		2MF + 4iS K+500		2MF-BO	
rechts												
links												
Fuer Z-TF	2MF-BO K+605		2MF-BO K+980		Fuer Z-TS		2 HO-BO + ZS		4 HO-BO			
rechts					rechts							
links					links							
Fuer Z-TS	3 iS + TB		2 HO-BO + TB		4 iS		3iS + ZS		2 HO-BO		2 HO-BO + 2iS	
rechts												
links												
Fuer G-TS	4 iS		2 BO		2 BO+ZS							
rechts												
links												
Schliessteile fuer Z-TS, Z-TF, G-TS					i.S. U-Profil			Rechts		Links		
Fallen- u Riegelschliessteile								Silber	Tricoat	Silber	Tricoat	
Ausfuehrung		U-6x32x9						- / + mm				
		Rechts		Links								
Anpressdr.	Silber	Tricoat	Silber	Tricoat								
	209154		209155									
Exenter	209151		209152									
f. E-Oeffner					i.S. ZA			355491		355503		
								- / + mm				

Schliessteile fuer Z-TF			Fallenschließteil ZT-F		MF-BO f. Z-TF				
Anpressdr.	Silber	Tricoat				Silber	Tricoat		
					rechts				
Excenter	209153				links				
f. E-Oeffner									
Schliessteile fuer Z-TS			TB-Schliessteil		Schliessteile fuer Z-TS			HO-BO ZA	
	Silber	Tricoat			Anpressdr.	Silber	Tricoat		
Rechts									
Links					- / + mm				
Schliessteile fuer Z-TS			HO-BO U		Riegelschliessteil f. 2-flg. Haustueren ZA (Z-TS, Z-TF,G-TS)				
Anpressdr.	Silber	Tricoat			Anpressdr.	Silber	Tricoat		
						206920			
- / + mm					- / + mm				
Schliessteile fuer G-TS			Hakenschliesst. U-Profil		Schliessteile fuer G-TS			Hakenschliessteil ZA	
Anpressdr.	Silber	Tricoat			Anpressdr.	Silber	Tricoat		
						204075			
- / + mm					- / + mm				
Schliessteile fuer G-TS			Bolzenschliesst. U-Profil		Schliessteile fuer G-TS			Bolzenschliessteil ZA	
Anpressdr.	Silber	Tricoat			Anpressdr.	Silber	Tricoat		
						204065			
- / + mm					- / + mm				
Fraesabdeckungen f. Schließteile		Schwarz	Verarbeitungshinweise						
Bolzen		355400							
Haken + Zusatzschloss		355402							
Riegelschliessteil		355404							
HO BO									
Fallen - u. Riegelschliessteil									

Rechtsansprüche aus der Anwendung der in diesem Profilblatt angegebenen Artikel können nicht geltend gemacht werden. Dieses Profilblatt ersetzt keine Pruefung in einem akkreditiertem Pruefinstitut !

RE04T
REHAU
S730_PROTECT









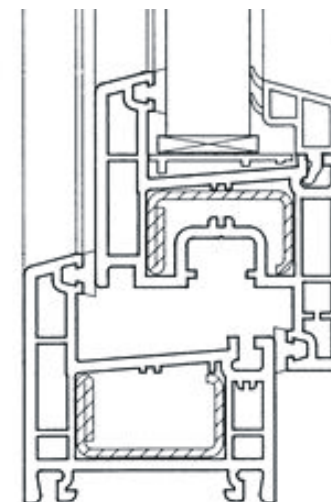



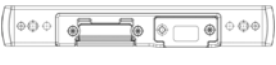

Rahmen

Fluegel

Falzluft mm: Ueberschlag mm: Versatz mm:

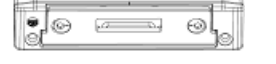

Schliessteilleisten U-Profil 												
Schloss	Silber	Tricoat	Silber	Tricoat	Silber	Tricoat	Silber	Tricoat	Silber	Tricoat	Silber	Tricoat
Fuer Z-TF	2MF + 2iS		2MF + 2iS K+500		2MF + 3iS K+1030		2MF + 4iS		2MF + 4iS K+500		2MF-BO	
rechts	210736		213716		213718		213720		213722		215596	
links	210737		213717		213719		213721		213723		215597	
Fuer Z-TF	2MF-BO K+605		2MF-BO K+980		Fuer Z-TS		2 HO-BO + ZS		4 HO-BO			
rechts	215598		215600		rechts				213668			
links	215599		215601		links				213669			
Fuer Z-TS	3 iS + TB		2 HO-BO + TB		4 iS		3iS + ZS		2 HO-BO		2 HO-BO + 2iS	
rechts	214345		214359		208574		208568		208599			
links	214346		214360		208573		208567		208600			
Fuer G-TS	4 iS		2 BO		2 BO+ZS							
rechts	208574		208570		208566							
links	208573		208569		208565							
Schliessteile fuer Z-TS, Z-TF, G-TS					i.S. U-Profil 			Rechts		Links		
Fallen- u Riegelschliessteile								Silber	Tricoat	Silber	Tricoat	
Ausfuehrung	U-6x32x9							207128		207129		
		Rechts		Links		- / + mm						
Anpressdr.	Silber	Tricoat	Silber	Tricoat								
	209159		209160		i.S. ZA 			355489		355501		
Exenter	209156		209157					- / + mm				
f. E-Oeffner					360606		360607					-2

Schliessteile fuer Z-TF			Fallenschließteil ZT-F	MF-BO f. Z-TF				
Anpressdr.	Silber	Tricoat			Silber	Tricoat		
	209988			rechts	215594			
Excenter	209158			links	215595			
f. E-Oeffner								
Schliessteile fuer Z-TS			TB-Schliessteil	Schliessteile fuer Z-TS			HO-BO ZA	
	Silber	Tricoat		Anpressdr.	Silber	Tricoat		
Rechts	214373				211553			
Links	214374			- / + mm	215094			-2
Schliessteile fuer Z-TS			HO-BO U	Riegelschliessteil f. 2-flg. Haustueren ZA (Z-TS, Z-TF,G-TS)				
Anpressdr.	Silber	Tricoat		Anpressdr.	Silber	Tricoat		
					206921			
- / + mm				- / + mm				
Schliessteile fuer G-TS			Hakenschliesst. U-Profil	Schliessteile fuer G-TS			Hakenschliessteil ZA	
Anpressdr.	Silber	Tricoat		Anpressdr.	Silber	Tricoat		
	207126				204073			
- / + mm				- / + mm				
Schliessteile fuer G-TS			Bolzenschliesst. U-Profil	Schliessteile fuer G-TS			Bolzenschliessteil ZA	
Anpressdr.	Silber	Tricoat		Anpressdr.	Silber	Tricoat		
	207127				204063			
- / + mm				- / + mm	215093			-2
Fraesabdeckungen f. Schließteile		Schwarz	Verarbeitungshinweise					
Bolzen		355399						
Haken + Zusatzschloss		355401						
Riegelschliessteil		355403						
HO BO		358027						
Fallen - u. Riegelschliessteil								

Rechtsansprüche aus der Anwendung der in diesem Profilblatt angegebenen Artikel können nicht geltend gemacht werden. Dieses Profilblatt ersetzt keine Pruefung in einem akkreditiertem Pruefinstitut !

RE30T
REHAU







Nordic Design



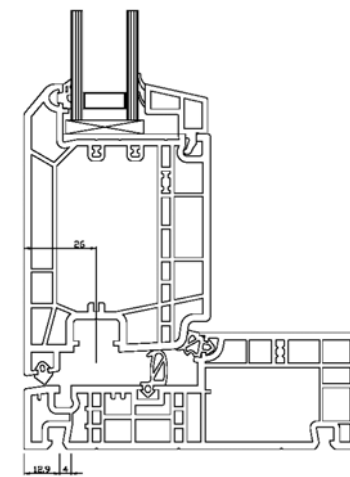



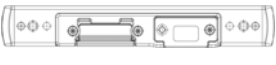

Rahmen

Fluegel

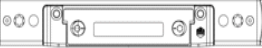
Falzluft mm: Ueberschlag mm: Versatz mm:



Schliessteilleisten U-Profil 												
Schloss	Silber	Tricoat	Silber	Tricoat	Silber	Tricoat	Silber	Tricoat	Silber	Tricoat	Silber	Tricoat
Fuer Z-TF	2MF + 2iS		2MF + 2iS K+500		2MF + 3iS K+1030		2MF + 4iS		2MF + 4iS K+500		2MF-BO	
rechts												
links												
Fuer Z-TF	2MF-BO K+605		2MF-BO K+980		Fuer Z-TS		2 HO-BO + ZS		4 HO-BO			
rechts					rechts							
links					links							
Fuer Z-TS	3 iS + TB		2 HO-BO + TB		4 iS		3iS + ZS		2 HO-BO		2 HO-BO + 2iS	
rechts												
links												
Fuer G-TS	4 iS		2 BO		2 BO+ZS							
rechts												
links												
Schliessteile fuer Z-TS, Z-TF, G-TS					i.S. U-Profil 			Rechts		Links		
Fallen- u Riegelschliessteile								Silber	Tricoat	Silber	Tricoat	
Ausfuehrung								- / + mm				
		Rechts		Links								
Anpressdr.	Silber	Tricoat	Silber	Tricoat								
					i.S. ZA 							
Exenter											- / + mm	
f. E-Oeffner												

Schliessteile fuer Z-TF			Fallenschließteil ZT-F			MF-BO f. Z-TF			
Anpressdr.	Silber	Tricoat			Silber	Tricoat			
				rechts					
Excenter				links					
f. E-Oeffner									
Schliessteile fuer Z-TS			TB-Schliessteil			Schliessteile fuer Z-TS			HO-BO ZA
	Silber	Tricoat		Anpressdr.	Silber	Tricoat			
Rechts									
Links				- / + mm					
Schliessteile fuer Z-TS			HO-BO U			Riegelschliessteil f. 2-flg. Haustueren ZA (Z-TS, Z-TF,G-TS)			
Anpressdr.	Silber	Tricoat		Anpressdr.	Silber	Tricoat			
- / + mm				- / + mm					
Schliessteile fuer G-TS			Hakenschliesst. U-Profil			Schliessteile fuer G-TS			Hakenschliessteil ZA
Anpressdr.	Silber	Tricoat		Anpressdr.	Silber	Tricoat			
- / + mm				- / + mm					
Schliessteile fuer G-TS			Bolzenschliesst. U-Profil			Schliessteile fuer G-TS			Bolzenschliessteil ZA
Anpressdr.	Silber	Tricoat		Anpressdr.	Silber	Tricoat			
- / + mm				- / + mm					
Fraesabdeckungen f. Schließteile		Schwarz	Verarbeitungshinweise						
Bolzen									
Haken + Zusatzschloss									
Riegelschliessteil									
HO BO									
Fallen - u. Riegelschliessteil									

Rechtsansprüche aus der Anwendung der in diesem Profilblatt angegebenen Artikel können nicht geltend gemacht werden. Dieses Profilblatt ersetzt keine Pruefung in einem akkreditiertem Pruefinstitut !

RE21T
REHAU
Tritec_PROTECT









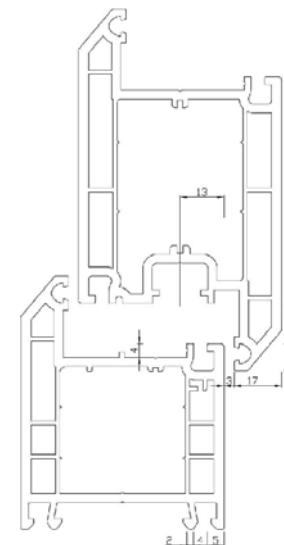



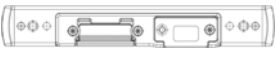
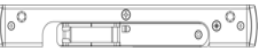

Rahmen

Fluegel

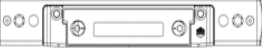
Falzluft mm: Ueberschlag mm: Versatz mm:



Schliessteilleisten U-Profil 												
Schloss	Silber	Tricoat	Silber	Tricoat	Silber	Tricoat	Silber	Tricoat	Silber	Tricoat	Silber	Tricoat
Fuer Z-TF	2MF + 2iS		2MF + 2iS K+500		2MF + 3iS K+1030		2MF + 4iS		2MF + 4iS K+500		2MF-BO	
rechts	213359				213365		213361		213363		216343	
links	213360				213366		213362		213364		216344	
Fuer Z-TF	2MF-BO K+605		2MF-BO K+980		Fuer Z-TS		2 HO-BO + ZS		4 HO-BO			
rechts	217963		217965		rechts				213355			
links	217964		217966		links				213356			
Fuer Z-TS	3 iS + TB		2 HO-BO + TB		4 iS		3iS + ZS		2 HO-BO		2 HO-BO + 2iS	
rechts					213357				213353			
links					213358				213354			
Fuer G-TS	4 iS		2 BO		2 BO+ZS							
rechts	213357											
links	213358											
Schliessteile fuer Z-TS, Z-TF, G-TS					i.S. U-Profil 			Rechts		Links		
Fallen- u Riegelschliessteile								Silber	Tricoat	Silber	Tricoat	
Ausfuehrung	U-6x32x9							207132		207133		
	Rechts		Links						- / + mm			
Anpressdr.	Silber	Tricoat	Silber	Tricoat								
	209164		209165					355490		355502		
Exenter	209161		209162									
f. E-Oeffner												

Schliessteile fuer Z-TF			Fallenschließteil ZT-F	MF-BO f. Z-TF				
Anpressdr.	Silber	Tricoat			Silber	Tricoat		
				rechts	217928			
				links	217929			
Excenter	209163							
f. E-Oeffner								
Schliessteile fuer Z-TS			TB-Schliessteil	Schliessteile fuer Z-TS			HO-BO ZA	
	Silber	Tricoat		Anpressdr.	Silber	Tricoat		
Rechts	216615							
Links	216616			- / + mm				
Schliessteile fuer Z-TS			HO-BO U	Riegelschliessteil f. 2-flg. Haustueren ZA (Z-TS, Z-TF,G-TS)				
Anpressdr.	Silber	Tricoat		Anpressdr.	Silber	Tricoat		
					206919			
- / + mm				- / + mm				
Schliessteile fuer G-TS			Hakenschliesst. U-Profil	Schliessteile fuer G-TS			Hakenschliessteil ZA	
Anpressdr.	Silber	Tricoat		Anpressdr.	Silber	Tricoat		
	207130				204074			
- / + mm				- / + mm				
Schliessteile fuer G-TS			Bolzenschliesst. U-Profil	Schliessteile fuer G-TS			Bolzenschliessteil ZA	
Anpressdr.	Silber	Tricoat		Anpressdr.	Silber	Tricoat		
	207131				204064			
- / + mm				- / + mm				
Fraesabdeckungen f. Schließteile		Schwarz	Verarbeitungshinweise					
Bolzen		355399	212294 Hook strike UK silver					
Haken + Zusatzschloss		355401	212579 Dooble slot strike UK silver					
Riegelschliessteil		355403	Latchplate without dust box: 211867 (216085 -2mm APD) right, 211868 (216086					
HO BO			Hook striker Uk without dust box: 212575 silver					
Fallen - u. Riegelschliessteil			Latchplate allan key adjuster without dust box -2mm APD: 217340 right, 217341					

Rechtsansprüche aus der Anwendung der in diesem Profilblatt angegebenen Artikel können nicht geltend gemacht werden. Dieses Profilblatt ersetzt keine Pruefung in einem akkreditiertem Pruefinstitut !

RE14T
REHAU







S706 IG (Gasketed)_PROTECT



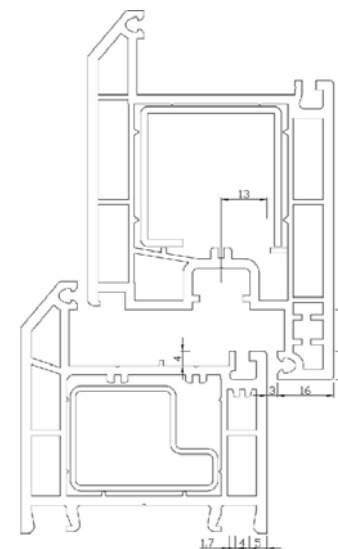



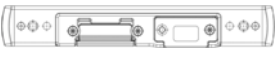
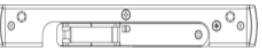

Rahmen

Fluegel

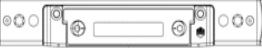
Falzlufth mm: Ueberschlag mm: Versatz mm:



Schliessteilleisten U-Profil 												
Schloss	Silber	Tricoat	Silber	Tricoat	Silber	Tricoat	Silber	Tricoat	Silber	Tricoat	Silber	Tricoat
Fuer Z-TF	2MF + 2iS		2MF + 2iS K+500		2MF + 3iS K+1030		2MF + 4iS		2MF + 4iS K+500		2MF-BO	
rechts	213359				213365		213361		213363		216343	
links	213360				213366		213362		213364		216344	
Fuer Z-TF	2MF-BO K+605		2MF-BO K+980		Fuer Z-TS		2 HO-BO + ZS		4 HO-BO			
rechts	217963		217965		rechts				213355			
links	217964		217966		links				213356			
Fuer Z-TS	3 iS + TB		2 HO-BO + TB		4 iS		3iS + ZS		2 HO-BO		2 HO-BO + 2iS	
rechts					213357				213353			
links					213358				213354			
Fuer G-TS	4 iS		2 BO		2 BO+ZS							
rechts	213357											
links	213358											
Schliessteile fuer Z-TS, Z-TF, G-TS					i.S. U-Profil 			Rechts		Links		
Fallen- u Riegelschliessteile								Silber	Tricoat	Silber	Tricoat	
Ausfuehrung	U-6x32x9							207132		207133		
		Rechts		Links					- / + mm			
Anpressdr.	Silber	Tricoat	Silber	Tricoat								
	209164		209165					355490		355502		
Exenter	209161		209162								- / + mm	
f. E-Oeffner												
					i.S. ZA 							

Schliessteile fuer Z-TF			Fallenschließteil ZT-F	MF-BO f. Z-TF				
Anpressdr.	Silber	Tricoat			Silber	Tricoat		
				rechts	217928			
				links	217929			
Excenter	209163							
f. E-Oeffner								
Schliessteile fuer Z-TS			TB-Schliessteil	Schliessteile fuer Z-TS			HO-BO ZA	
	Silber	Tricoat		Anpressdr.	Silber	Tricoat		
Rechts	216615							
Links	216616			- / + mm				
Schliessteile fuer Z-TS			HO-BO U	Riegelschliessteil f. 2-flg. Haustueren ZA (Z-TS, Z-TF,G-TS)				
Anpressdr.	Silber	Tricoat		Anpressdr.	Silber	Tricoat		
					206919			
- / + mm				- / + mm				
Schliessteile fuer G-TS			Hakenschliesst. U-Profil	Schliessteile fuer G-TS			Hakenschliessteil ZA	
Anpressdr.	Silber	Tricoat		Anpressdr.	Silber	Tricoat		
	207130				204074			
- / + mm				- / + mm				
Schliessteile fuer G-TS			Bolzenschliesst. U-Profil	Schliessteile fuer G-TS			Bolzenschliessteil ZA	
Anpressdr.	Silber	Tricoat		Anpressdr.	Silber	Tricoat		
	207131				204064			
- / + mm				- / + mm				
Fraesabdeckungen f. Schließteile		Schwarz	Verarbeitungshinweise					
Bolzen		355399	212294 Hook strike UK silver					
Haken + Zusatzschloss		355401	212579 Dooble slot strike UK silver					
Riegelschliessteil		355403	Latchplate without dust box: 211867 (216085 -2mm APD) right, 211868 (216086					
HO BO			Hook striker Uk without dust box: 212575 silver					
Fallen - u. Riegelschliessteil			Latchplate allan key adjuster without dust box -2mm APD: 217340 right, 217341					

Rechtsansprüche aus der Anwendung der in diesem Profilblatt angegebenen Artikel können nicht geltend gemacht werden. Dieses Profilblatt ersetzt keine Pruefung in einem akkreditiertem Pruefinstitut !

RO01T
ROPLASTO
Syste 7001 AD_PROTECT









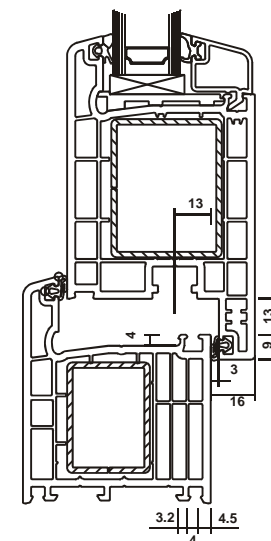



Rahmen

Fluegel

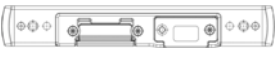
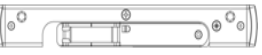
Falzluft mm: Ueberschlag mm: Versatz mm:

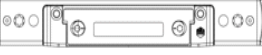

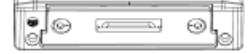
Schliessteilleisten U-Profil 												
Schloss	Silber	Tricoat	Silber	Tricoat	Silber	Tricoat	Silber	Tricoat	Silber	Tricoat	Silber	Tricoat
Fuer Z-TF	2MF + 2iS		2MF + 2iS K+500		2MF + 3iS K+1030		2MF + 4iS		2MF + 4iS K+500		2MF-BO	
rechts												
links												
Fuer Z-TF	2MF-BO K+605		2MF-BO K+980		Fuer Z-TS		2 HO-BO + ZS		4 HO-BO			
rechts					rechts				214985			
links					links				214986			
Fuer Z-TS	3 iS + TB		2 HO-BO + TB		4 iS		3iS + ZS		2 HO-BO		2 HO-BO + 2iS	
rechts									217634			
links									217635			
Fuer G-TS	4 iS		2 BO		2 BO+ZS							
rechts												
links												
Schliessteile fuer Z-TS, Z-TF, G-TS					i.S. U-Profil 			Rechts		Links		
Fallen- u Riegelschliessteile								Silber	Tricoat	Silber	Tricoat	
Ausfuehrung		U-6x32x9						- / + mm				
		Rechts		Links								
Anpressdr.	Silber	Tricoat	Silber	Tricoat								
					i.S. ZA 			- / + mm				
Exenter												
f. E-Oeffner												

Schliessteile fuer Z-TF			Fallenschließteil ZT-F	MF-BO f. Z-TF				
Anpressdr.	Silber	Tricoat			Silber	Tricoat		
				rechts				
Excenter				links				
f. E-Oeffner								
Schliessteile fuer Z-TS			TB-Schliessteil	Schliessteile fuer Z-TS			HO-BO ZA	
	Silber	Tricoat		Anpressdr.	Silber	Tricoat		
Rechts	215432							
Links	215433			- / + mm				
Schliessteile fuer Z-TS			HO-BO U	Riegelschliessteil f. 2-flg. Haustueren ZA (Z-TS, Z-TF,G-TS)				
Anpressdr.	Silber	Tricoat		Anpressdr.	Silber	Tricoat		
- / + mm				- / + mm				
Schliessteile fuer G-TS			Hakenschliesst. U-Profil	Schliessteile fuer G-TS			Hakenschliessteil ZA	
Anpressdr.	Silber	Tricoat		Anpressdr.	Silber	Tricoat		
- / + mm				- / + mm				
Schliessteile fuer G-TS			Bolzenschliesst. U-Profil	Schliessteile fuer G-TS			Bolzenschliessteil ZA	
Anpressdr.	Silber	Tricoat		Anpressdr.	Silber	Tricoat		
- / + mm				- / + mm				
Fraesabdeckungen f. Schließteile		Schwarz	Verarbeitungshinweise					
Bolzen			4 HO-BO -2mm APD Silber: 217889 rechts, 217890 links;					
Haken + Zusatzschloss								
Riegelschliessteil								
HO BO								
Fallen - u. Riegelschliessteil								

Rechtsansprüche aus der Anwendung der in diesem Profilblatt angegebenen Artikel können nicht geltend gemacht werden. Dieses Profilblatt ersetzt keine Pruefung in einem akkreditiertem Pruefinstitut !

SA07T





SALAMANDER**Design 2D_PROTECT**



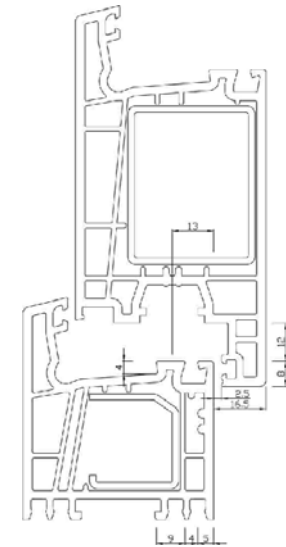



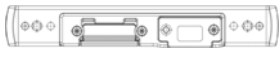
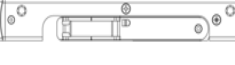

Rahmen 2010020,210026;

Fluegel 211040;

Falzluft mm: 12 Ueberschlag mm: 20 Versatz mm: 13



Schliessteilleisten U-Profil 												
Schloss	Silber	Tricoat	Silber	Tricoat	Silber	Tricoat	Silber	Tricoat	Silber	Tricoat	Silber	Tricoat
Fuer Z-TF	2MF + 2iS		2MF + 2iS K+500		2MF + 3iS K+1030		2MF + 4iS		2MF + 4iS K+500		2MF-BO	
rechts	210738		213724		213726		213728		213730		215402	
links	210739		213725		213727		213729		213731		215403	
Fuer Z-TF	2MF-BO K+605		2MF-BO K+980		Fuer Z-TS		2 HO-BO + ZS		4 HO-BO			
rechts	215404		215406		rechts				213670			
links	215405		215407		links				213671			
Fuer Z-TS	3 iS + TB		2 HO-BO + TB		4 iS		3iS + ZS		2 HO-BO		2 HO-BO + 2iS	
rechts	214343		214357		208511		208505		208462		216368	
links	214344		214358		208510		208504		208463		216369	
Fuer G-TS	4 iS		2 BO		2 BO+ZS							
rechts	208511		208507		208503							
links	208510		208506		208502							
Schliessteile fuer Z-TS, Z-TF, G-TS					i.S. U-Profil 			Rechts		Links		
Fallen- u Riegelschliessteile								Silber	Tricoat	Silber	Tricoat	
Ausfuehrung	U-6x32x9							207136		207137		
	Rechts		Links						- / + mm			
Anpressdr.	Silber	Tricoat	Silber	Tricoat								
	209169		209170					355493		355505		
Exenter	209166		209167					- / + mm				
f. E-Oeffner												

Schliessteile fuer Z-TF			Fallenschließteil ZT-F	MF-BO f. Z-TF				
Anpressdr.	Silber	Tricoat			Silber	Tricoat		
	209989			rechts	215411			
Excenter	209168			links	215412			
f. E-Oeffner								
Schliessteile fuer Z-TS			TB-Schliessteil	Schliessteile fuer Z-TS			HO-BO ZA	
	Silber	Tricoat		Anpressdr.	Silber	Tricoat		
Rechts	214371				211554			
Links	214372			- / + mm				
Schliessteile fuer Z-TS			HO-BO U	Riegelschliessteil f. 2-flg. Haustueren ZA (Z-TS, Z-TF,G-TS)				
Anpressdr.	Silber	Tricoat		Anpressdr.	Silber	Tricoat		
					206922			
- / + mm				- / + mm				
Schliessteile fuer G-TS			Hakenschliesst. U-Profil	Schliessteile fuer G-TS			Hakenschliessteil ZA	
Anpressdr.	Silber	Tricoat		Anpressdr.	Silber	Tricoat		
	207134				204077			
- / + mm				- / + mm				
Schliessteile fuer G-TS			Bolzenschliesst. U-Profil	Schliessteile fuer G-TS			Bolzenschliessteil ZA	
Anpressdr.	Silber	Tricoat		Anpressdr.	Silber	Tricoat		
	207135				204067			
- / + mm				- / + mm				
Fraesabdeckungen f. Schließteile		Schwarz	Verarbeitungshinweise					
Bolzen		355399	STL 2HO-BO -2mm APD silber: 217168 rechts, 217169 links;					
Haken + Zusatzschloss		355401						
Riegelschliessteil		355403						
HO BO		358027						
Fallen - u. Riegelschliessteil								

Rechtsansprüche aus der Anwendung der in diesem Profilblatt angegebenen Artikel können nicht geltend gemacht werden. Dieses Profilblatt ersetzt keine Pruefung in einem akkreditiertem Pruefinstitut !

SA04T

SALAMANDER**Design 3D_PROTECT**







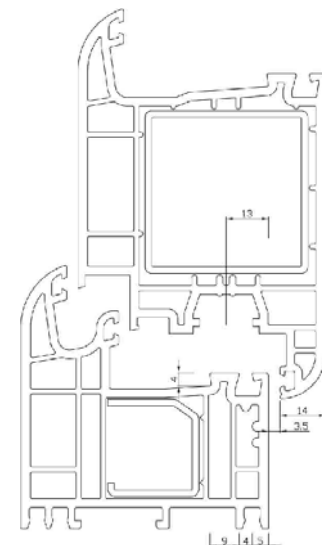

Rahmen 110 220, 110 225;

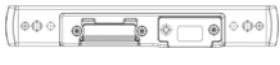
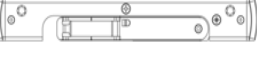
Fluegel 211 240, 211 140;

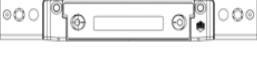
Falzlufth mm: 12 Ueberschlag mm: 20 Versatz mm: 13



Schliessteilleisten U-Profil												
Schloss	Silber	Tricoat	Silber	Tricoat	Silber	Tricoat	Silber	Tricoat	Silber	Tricoat	Silber	Tricoat
Fuer Z-TF	2MF + 2iS		2MF + 2iS K+500		2MF + 3iS K+1030		2MF + 4iS		2MF + 4iS K+500		2MF-BO	
rechts	210738		213724		213726		213728		213730		215402	
links	210739		213725		213727		213729		213731		215403	
Fuer Z-TF	2MF-BO K+605		2MF-BO K+980		Fuer Z-TS		2 HO-BO + ZS		4 HO-BO			
rechts	215404		215406		rechts				213670			
links	215405		215407		links				213671			
Fuer Z-TS	3 iS + TB		2 HO-BO + TB		4 iS		3iS + ZS		2 HO-BO		2 HO-BO + 2iS	
rechts	214343		214357		208511		208505		208462		216368	
links	214344		214358		208510		208504		208463		216369	
Fuer G-TS	4 iS		2 BO		2 BO+ZS							
rechts	208511		208507		208503							
links	208510		208506		208502							
Schliessteile fuer Z-TS, Z-TF, G-TS					i.S. U-Profil			Rechts		Links		
Fallen- u Riegelschliessteile								Silber	Tricoat	Silber	Tricoat	
Ausfuehrung	U-6x32x9				207136		207137					
		Rechts		Links		- / + mm						
Anpressdr.	Silber	Tricoat	Silber	Tricoat								
	209169		209170									
Exenter	209166		209167									
f. E-Oeffner					i.S. ZA			355493		355505		
						- / + mm						

Schliessteile fuer Z-TF			Fallenschließteil ZT-F		MF-BO f. Z-TF				
Anpressdr.	Silber	Tricoat				Silber	Tricoat		
	209989				rechts	215411			
Excenter	209168				links	215412			
f. E-Oeffner									
Schliessteile fuer Z-TS			TB-Schliessteil		Schliessteile fuer Z-TS			HO-BO ZA	
	Silber	Tricoat			Anpressdr.	Silber	Tricoat		
Rechts	214371					211554			
Links	214372				- / + mm				
Schliessteile fuer Z-TS			HO-BO U		Riegelschliessteil f. 2-flg. Haustueren ZA (Z-TS, Z-TF,G-TS)				
Anpressdr.	Silber	Tricoat			Anpressdr.	Silber	Tricoat		
						206922			
- / + mm					- / + mm				
Schliessteile fuer G-TS			Hakenschliesst. U-Profil		Schliessteile fuer G-TS			Hakenschliessteil ZA	
Anpressdr.	Silber	Tricoat			Anpressdr.	Silber	Tricoat		
	207134					204077			
- / + mm					- / + mm				
Schliessteile fuer G-TS			Bolzenschliesst. U-Profil		Schliessteile fuer G-TS			Bolzenschliessteil ZA	
Anpressdr.	Silber	Tricoat			Anpressdr.	Silber	Tricoat		
	207135					204067			
- / + mm					- / + mm				
Fraesabdeckungen f. Schließteile		Schwarz	Verarbeitungshinweise						
Bolzen		355399	STL 2HO-BO -2mm APD silber: 217168 rechts, 217169 links;						
Haken + Zusatzschloss		355401							
Riegelschliessteil		355403							
HO BO		358027							
Fallen - u. Riegelschliessteil									

Rechtsansprüche aus der Anwendung der in diesem Profilblatt angegebenen Artikel können nicht geltend gemacht werden. Dieses Profilblatt ersetzt keine Pruefung in einem akkreditiertem Pruefinstitut !

SA08T

SALAMANDER

bluEvolution_PROTECT









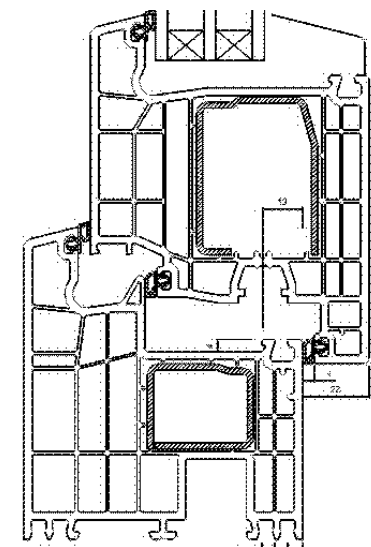

Rahmen 170.430

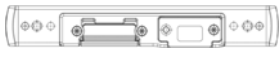
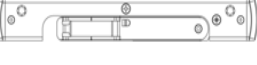
Fluegel 171.030

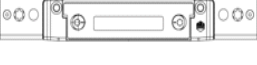
Falzlufth mm: 12 Ueberschlag mm: 20 Versatz mm: 13



Schliessteilleisten U-Profil													
Schloss	Silber	Tricoat	Silber	Tricoat	Silber	Tricoat	Silber	Tricoat	Silber	Tricoat	Silber	Tricoat	
Fuer Z-TF	2MF + 2iS		2MF + 2iS K+500		2MF + 3iS K+1030		2MF + 4iS		2MF + 4iS K+500		2MF-BO		
rechts	213603										216373		
links	213604										216374		
Fuer Z-TF	2MF-BO K+605		2MF-BO K+980		Fuer Z-TS		2 HO-BO + ZS		4 HO-BO				
rechts	216375		216377		rechts								
links	216376		216378		links								
Fuer Z-TS	3 iS + TB		2 HO-BO + TB		4 iS		3iS + ZS		2 HO-BO		2 HO-BO + 2iS		
rechts			216797		213598		213600		213606				
links			216798		213599		213602		213607				
Fuer G-TS	4 iS		2 BO		2 BO+ZS								
rechts	213598		213639		213645								
links	213599		213640		213646								
Schliessteile fuer Z-TS, Z-TF, G-TS					i.S. U-Profil			Rechts		Links			
Fallen- u Riegelschliessteile								Silber	Tricoat	Silber	Tricoat		
Ausfuehrung	U-6x32x9							- / + mm					
		Rechts		Links									
Anpressdr.	Silber	Tricoat	Silber	Tricoat									
	213592		213593										
Exenter	216382		216383										
f. E-Oeffner								362138		362135			
					i.S. ZA			- / + mm					

Schliessteile fuer Z-TF			Fallenschließteil ZT-F	MF-BO f. Z-TF				
Anpressdr.	Silber	Tricoat			Silber	Tricoat		
	213594			rechts	216371			
Excenter				links	216372			
f. E-Oeffner								
Schliessteile fuer Z-TS			TB-Schliessteil	Schliessteile fuer Z-TS			HO-BO ZA	
	Silber	Tricoat		Anpressdr.	Silber	Tricoat		
Rechts	216795				213595			
Links	216796			- / + mm				
Schliessteile fuer Z-TS			HO-BO U	Riegelschliessteil f. 2-flg. Haustueren ZA (Z-TS, Z-TF,G-TS)				
Anpressdr.	Silber	Tricoat		Anpressdr.	Silber	Tricoat		
					213597			
- / + mm				- / + mm				
Schliessteile fuer G-TS			Hakenschliesst. U-Profil	Schliessteile fuer G-TS			Hakenschliessteil ZA	
Anpressdr.	Silber	Tricoat		Anpressdr.	Silber	Tricoat		
					213651			
- / + mm				- / + mm				
Schliessteile fuer G-TS			Bolzenschliesst. U-Profil	Schliessteile fuer G-TS			Bolzenschliessteil ZA	
Anpressdr.	Silber	Tricoat		Anpressdr.	Silber	Tricoat		
	216379				213652			
- / + mm				- / + mm				
Fraesabdeckungen f. Schließteile		Schwarz	Verarbeitungshinweise					
Bolzen		355399						
Haken + Zusatzschloss		355401						
Riegelschliessteil		355403						
HO BO		358027						
Fallen - u. Riegelschliessteil								

Rechtsansprüche aus der Anwendung der in diesem Profilblatt angegebenen Artikel können nicht geltend gemacht werden. Dieses Profilblatt ersetzt keine Pruefung in einem akkreditiertem Pruefinstitut !

SA06T

SALAMANDER

Streamline 76_PROTECT









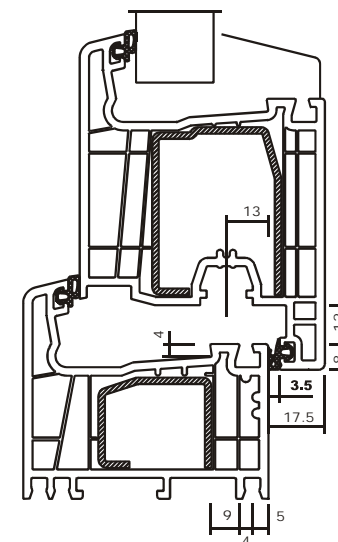

Rahmen 250220

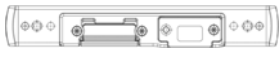
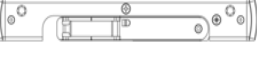
Fluegel 251030

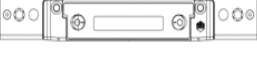
Falzlufth mm: 12 Ueberschlag mm: 20 Versatz mm: 13



Schliessteilleisten U-Profil												
Schloss	Silber	Tricoat	Silber	Tricoat	Silber	Tricoat	Silber	Tricoat	Silber	Tricoat	Silber	Tricoat
Fuer Z-TF	2MF + 2iS		2MF + 2iS K+500		2MF + 3iS K+1030		2MF + 4iS		2MF + 4iS K+500		2MF-BO	
rechts	210738		213724		213726		213728		213730		215402	
links	210739		213725		213727		213729		213731		215403	
Fuer Z-TF	2MF-BO K+605		2MF-BO K+980		Fuer Z-TS		2 HO-BO + ZS		4 HO-BO			
rechts	215404		215406		rechts				213670			
links	215405		215407		links				213671			
Fuer Z-TS	3 iS + TB		2 HO-BO + TB		4 iS		3iS + ZS		2 HO-BO		2 HO-BO + 2iS	
rechts	214343		214357		208511		208505		208462		216368	
links	214344		214358		208510		208504		208463		216369	
Fuer G-TS	4 iS		2 BO		2 BO+ZS							
rechts	208511		208507		208503							
links	208510		208506		208502							
Schliessteile fuer Z-TS, Z-TF, G-TS					i.S. U-Profil			Rechts		Links		
Fallen- u Riegelschliessteile								Silber	Tricoat	Silber	Tricoat	
Ausfuehrung	U-6x32x9				207136		207137					
		Rechts		Links		- / + mm						
Anpressdr.	Silber	Tricoat	Silber	Tricoat								
	209169		209170									
Exenter	209166		209167									
f. E-Oeffner					i.S. ZA			355493		355505		
						- / + mm						

Schliessteile fuer Z-TF			Fallenschließteil ZT-F		MF-BO f. Z-TF				
Anpressdr.	Silber	Tricoat				Silber	Tricoat		
	209989				rechts	215411			
Excenter	209168				links	215412			
f. E-Oeffner									
Schliessteile fuer Z-TS			TB-Schliessteil		Schliessteile fuer Z-TS			HO-BO ZA	
	Silber	Tricoat			Anpressdr.	Silber	Tricoat		
Rechts	214371					211554			
Links	214372				- / + mm				
Schliessteile fuer Z-TS			HO-BO U		Riegelschliessteil f. 2-flg. Haustueren ZA (Z-TS, Z-TF,G-TS)				
Anpressdr.	Silber	Tricoat			Anpressdr.	Silber	Tricoat		
						206922			
- / + mm					- / + mm				
Schliessteile fuer G-TS			Hakenschliesst. U-Profil		Schliessteile fuer G-TS			Hakenschliessteil ZA	
Anpressdr.	Silber	Tricoat			Anpressdr.	Silber	Tricoat		
	207134					204077			
- / + mm					- / + mm				
Schliessteile fuer G-TS			Bolzenschliesst. U-Profil		Schliessteile fuer G-TS			Bolzenschliessteil ZA	
Anpressdr.	Silber	Tricoat			Anpressdr.	Silber	Tricoat		
	207135					204067			
- / + mm					- / + mm				
Fraesabdeckungen f. Schließteile		Schwarz	Verarbeitungshinweise						
Bolzen		355399	STL 2HO-BO -2mm APD silber: 217168 rechts, 217169 links;						
Haken + Zusatzschloss		355401							
Riegelschliessteil		355403							
HO BO		358027							
Fallen - u. Riegelschliessteil									

Rechtsansprüche aus der Anwendung der in diesem Profilblatt angegebenen Artikel können nicht geltend gemacht werden. Dieses Profilblatt ersetzt keine Pruefung in einem akkreditiertem Pruefinstitut !





SC07T
SCHUECO
Si 82_PROTECT









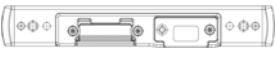

Rahmen

Fluegel

Falzluft mm: Ueberschlag mm: Versatz mm:

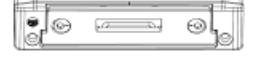
Schliessteilleisten U-Profil 												
Schloss	Silber	Tricoat	Silber	Tricoat	Silber	Tricoat	Silber	Tricoat	Silber	Tricoat	Silber	Tricoat
Fuer Z-TF	2MF + 2iS		2MF + 2iS K+500		2MF + 3iS K+1030		2MF + 4iS		2MF + 4iS K+500		2MF-BO	
rechts	210726		213700		213702		213704		213706		216928	
links	210727		213701		213703		213705		213707		216929	
Fuer Z-TF	2MF-BO K+605		2MF-BO K+980		Fuer Z-TS		2 HO-BO + ZS		4 HO-BO			
rechts	216931		216932		rechts				213654			
links			216933		links				213655			
Fuer Z-TS	3 iS + TB		2 HO-BO + TB		4 iS		3iS + ZS		2 HO-BO		2 HO-BO + 2iS	
rechts			216793		208536		208530		211630			
links			216794		208535		208529		211631			
Fuer G-TS	4 iS		2 BO		2 BO+ZS							
rechts	208536		208532		208528							
links	208535		208531		208527							
Schliessteile fuer Z-TS, Z-TF, G-TS					i.S. U-Profil 			Rechts		Links		
Fallen- u Riegelschliessteile								Silber	Tricoat	Silber	Tricoat	
Ausfuehrung	U-6x32x9					207140		207141				
	Rechts		Links			- / + mm						
Anpressdr.	Silber	Tricoat	Silber	Tricoat								
	209094		209095									
Exenter	209091		209092									
f. E-Oeffner												
					i.S. ZA 			355494		355506		
						- / + mm						

Schliessteile fuer Z-TF			Fallenschließteil ZT-F	MF-BO f. Z-TF				
Anpressdr.	Silber	Tricoat			Silber	Tricoat		
	209977			rechts	216926			
Excenter	209093			links	216927			
f. E-Oeffner								
Schliessteile fuer Z-TS			TB-Schliessteil	Schliessteile fuer Z-TS			HO-BO ZA	
	Silber	Tricoat		Anpressdr.	Silber	Tricoat		
Rechts	215786				211557			
Links	215787			- / + mm				
Schliessteile fuer Z-TS			HO-BO U	Riegelschliessteil f. 2-flg. Haustueren ZA (Z-TS, Z-TF,G-TS)				
Anpressdr.	Silber	Tricoat		Anpressdr.	Silber	Tricoat		
					206923			
- / + mm				- / + mm				
Schliessteile fuer G-TS			Hakenschliesst. U-Profil	Schliessteile fuer G-TS			Hakenschliessteil ZA	
Anpressdr.	Silber	Tricoat		Anpressdr.	Silber	Tricoat		
	207138				204078			
- / + mm				- / + mm				
Schliessteile fuer G-TS			Bolzenschliesst. U-Profil	Schliessteile fuer G-TS			Bolzenschliessteil ZA	
Anpressdr.	Silber	Tricoat		Anpressdr.	Silber	Tricoat		
	207139				204068			
- / + mm				- / + mm				
Fraesabdeckungen f. Schließteile		Schwarz	Verarbeitungshinweise					
Bolzen		355399						
Haken + Zusatzschloss		355401						
Riegelschliessteil		355403						
HO BO		358027						
Fallen - u. Riegelschliessteil								

Rechtsansprüche aus der Anwendung der in diesem Profilblatt angegebenen Artikel können nicht geltend gemacht werden. Dieses Profilblatt ersetzt keine Pruefung in einem akkreditiertem Pruefinstitut !

SC05T
SCHUECO
CT 70 - AS_PROTECT









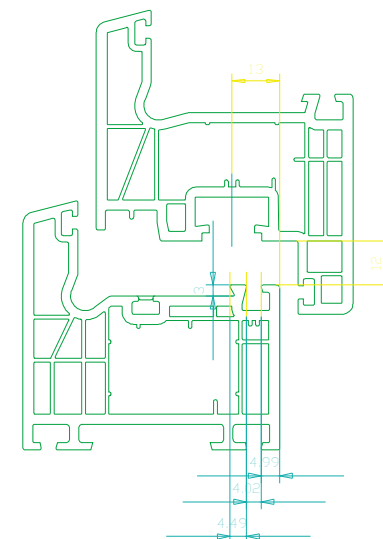

Rahmen

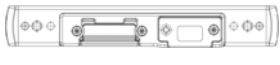
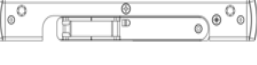
Fluegel

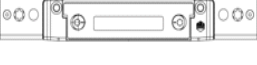
Falzlufth mm: Ueberschlag mm: Versatz mm:



Schliessteilleisten U-Profil													
Schloss	Silber	Tricoat	Silber	Tricoat	Silber	Tricoat	Silber	Tricoat	Silber	Tricoat	Silber	Tricoat	
Fuer Z-TF	2MF + 2iS		2MF + 2iS K+500		2MF + 3iS K+1030		2MF + 4iS		2MF + 4iS K+500		2MF-BO		
rechts	210726		213700		213702		213704		213706		216928		
links	210727		213701		213703		213705		213707		216929		
Fuer Z-TF	2MF-BO K+605		2MF-BO K+980		Fuer Z-TS		2 HO-BO + ZS		4 HO-BO				
rechts	216931		216932		rechts				213654				
links			216933		links				213655				
Fuer Z-TS	3 iS + TB		2 HO-BO + TB		4 iS		3iS + ZS		2 HO-BO		2 HO-BO + 2iS		
rechts			216793		208536		208530		211630				
links			216794		208535		208529		211631				
Fuer G-TS	4 iS		2 BO		2 BO+ZS								
rechts	208536		208532		208528								
links	208535		208531		208527								
Schliessteile fuer Z-TS, Z-TF, G-TS					i.S. U-Profil			Rechts		Links			
Fallen- u Riegelschliessteile								Silber	Tricoat	Silber	Tricoat		
Ausfuehrung					U-6x32x9			207140		207141			
		Rechts		Links		- / + mm							
Anpressdr.	Silber	Tricoat	Silber	Tricoat									
	209094		209095										
Exenter	209091		209092										
f. E-Oeffner													
					i.S. ZA			355494		355506			
								- / + mm					

Schliessteile fuer Z-TF			Fallenschließteil ZT-F		MF-BO f. Z-TF				
Anpressdr.	Silber	Tricoat				Silber	Tricoat		
	209977				rechts	216926			
Excenter	209093				links	216927			
f. E-Oeffner									
Schliessteile fuer Z-TS			TB-Schliessteil		Schliessteile fuer Z-TS			HO-BO ZA	
	Silber	Tricoat			Anpressdr.	Silber	Tricoat		
Rechts	215786					211557			
Links	215787				- / + mm				
Schliessteile fuer Z-TS			HO-BO U		Riegelschliessteil f. 2-flg. Haustueren ZA (Z-TS, Z-TF,G-TS)				
Anpressdr.	Silber	Tricoat			Anpressdr.	Silber	Tricoat		
						206923			
- / + mm					- / + mm				
Schliessteile fuer G-TS			Hakenschliesst. U-Profil		Schliessteile fuer G-TS			Hakenschliessteil ZA	
Anpressdr.	Silber	Tricoat			Anpressdr.	Silber	Tricoat		
	207138					204078			
- / + mm					- / + mm				
Schliessteile fuer G-TS			Bolzenschliesst. U-Profil		Schliessteile fuer G-TS			Bolzenschliessteil ZA	
Anpressdr.	Silber	Tricoat			Anpressdr.	Silber	Tricoat		
	207139					204068			
- / + mm					- / + mm				
Fraesabdeckungen f. Schließteile		Schwarz	Verarbeitungshinweise						
Bolzen		355399							
Haken + Zusatzschloss		355401							
Riegelschliessteil		355403							
HO BO		358027							
Fallen - u. Riegelschliessteil									

Rechtsansprüche aus der Anwendung der in diesem Profilblatt angegebenen Artikel können nicht geltend gemacht werden. Dieses Profilblatt ersetzt keine Pruefung in einem akkreditiertem Pruefinstitut !

SC02T
SCHUECO
Corona AS_PROTECT









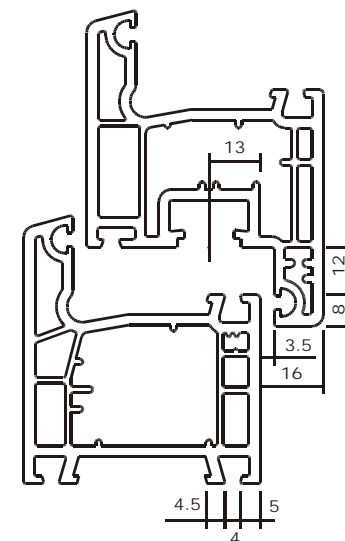



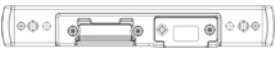

Rahmen

Fluegel

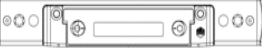
Falzlufth mm: Ueberschlag mm: Versatz mm:



Schliessteilleisten U-Profil 														
Schloss	Silber	Tricoat	Silber	Tricoat	Silber	Tricoat	Silber	Tricoat	Silber	Tricoat	Silber	Tricoat		
Fuer Z-TF	2MF + 2iS		2MF + 2iS K+500		2MF + 3iS K+1030		2MF + 4iS		2MF + 4iS K+500		2MF-BO			
rechts	210728		212806		212808		212810		212812		215544			
links	210729		212807		212809		212811		212813		215545			
Fuer Z-TF	2MF-BO K+605		2MF-BO K+980		Fuer Z-TS		2 HO-BO + ZS		4 HO-BO					
rechts	215546		215548		rechts		215017		213656					
links	215547		215549		links		215018		213657					
Fuer Z-TS	3 iS + TB		2 HO-BO + TB		4 iS		3iS + ZS		2 HO-BO		2 HO-BO + 2iS			
rechts														
links														
Fuer G-TS	4 iS		2 BO		2 BO+ZS									
rechts														
links														
Schliessteile fuer Z-TS, Z-TF, G-TS					i.S. U-Profil 			Rechts		Links				
Fallen- u Riegelschliessteile								Silber	Tricoat	Silber	Tricoat			
Ausfuehrung		U-6x32x9						- / + mm						
		Rechts		Links										
Anpressdr.	Silber	Tricoat	Silber	Tricoat										
	209174		209175											
Exenter	209171		209172											
f. E-Oeffner														
					i.S. ZA 			357375		357376				
								- / + mm						

Schliessteile fuer Z-TF			Fallenschließteil ZT-F		MF-BO f. Z-TF				
Anpressdr.	Silber	Tricoat				Silber	Tricoat		
	209990				rechts	215550			
Excenter	209173				links	215551			
f. E-Oeffner									
Schliessteile fuer Z-TS			TB-Schliessteil		Schliessteile fuer Z-TS			HO-BO ZA	
	Silber	Tricoat			Anpressdr.	Silber	Tricoat		
Rechts									
Links					- / + mm				
Schliessteile fuer Z-TS			HO-BO U		Riegelschliessteil f. 2-flg. Haustueren ZA (Z-TS, Z-TF,G-TS)				
Anpressdr.	Silber	Tricoat			Anpressdr.	Silber	Tricoat		
						206941			
- / + mm					- / + mm				
Schliessteile fuer G-TS			Hakenschliesst. U-Profil		Schliessteile fuer G-TS			Hakenschliessteil ZA	
Anpressdr.	Silber	Tricoat			Anpressdr.	Silber	Tricoat		
						206908			
- / + mm					- / + mm				
Schliessteile fuer G-TS			Bolzenschliesst. U-Profil		Schliessteile fuer G-TS			Bolzenschliessteil ZA	
Anpressdr.	Silber	Tricoat			Anpressdr.	Silber	Tricoat		
						206917			
- / + mm					- / + mm				
Fraesabdeckungen f. Schließteile		Schwarz	Verarbeitungshinweise						
Bolzen		355399							
Haken + Zusatzschloss		355401							
Riegelschliessteil		355403							
HO BO									
Fallen - u. Riegelschliessteil									

Rechtsansprüche aus der Anwendung der in diesem Profilblatt angegebenen Artikel können nicht geltend gemacht werden. Dieses Profilblatt ersetzt keine Pruefung in einem akkreditiertem Pruefinstitut !

SC08T
SCHUECO
AWS 60 Typ I









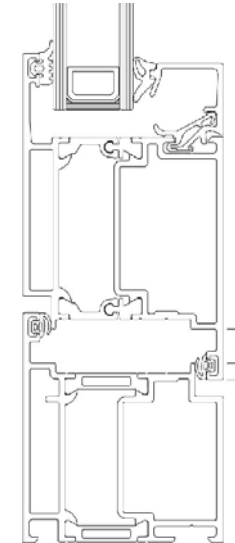



Rahmen

Fluegel

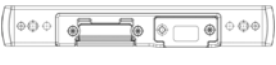
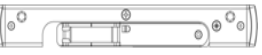
Falzluft mm: Ueberschlag mm: Versatz mm:

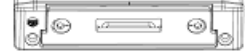

Schliessteilleisten U-Profil 												
Schloss	Silber	Tricoat	Silber	Tricoat	Silber	Tricoat	Silber	Tricoat	Silber	Tricoat	Silber	Tricoat
Fuer Z-TF	2MF + 2iS		2MF + 2iS K+500		2MF + 3iS K+1030		2MF + 4iS		2MF + 4iS K+500		2MF-BO	
rechts												
links												
Fuer Z-TF	2MF-BO K+605		2MF-BO K+980		Fuer Z-TS		2 HO-BO + ZS		4 HO-BO			
rechts					rechts							
links					links							
Fuer Z-TS	3 iS + TB		2 HO-BO + TB		4 iS		3iS + ZS		2 HO-BO		2 HO-BO + 2iS	
rechts												
links												
Fuer G-TS	4 iS		2 BO		2 BO+ZS							
rechts												
links												
Schliessteile fuer Z-TS, Z-TF, G-TS					i.S. U-Profil 			Rechts		Links		
Fallen- u Riegelschliessteile								Silber	Tricoat	Silber	Tricoat	
Ausfuehrung								- / + mm				
		Rechts		Links								
Anpressdr.	Silber	Tricoat	Silber	Tricoat								
					i.S. ZA 							
Exenter								- / + mm				
f. E-Oeffner												

Schliessteile fuer Z-TF			Fallenschließteil ZT-F	MF-BO f. Z-TF				
Anpressdr.	Silber	Tricoat			Silber	Tricoat		
				rechts				
Excenter				links				
f. E-Oeffner								
Schliessteile fuer Z-TS			TB-Schliessteil	Schliessteile fuer Z-TS			HO-BO ZA	
	Silber	Tricoat		Anpressdr.	Silber	Tricoat		
Rechts								
Links				- / + mm				
Schliessteile fuer Z-TS			HO-BO U	Riegelschliessteil f. 2-flg. Haustueren ZA (Z-TS, Z-TF,G-TS)				
Anpressdr.	Silber	Tricoat		Anpressdr.	Silber	Tricoat		
				- / + mm				
- / + mm								
Schliessteile fuer G-TS			Hakenschliesst. U-Profil	Schliessteile fuer G-TS			Hakenschliessteil ZA	
Anpressdr.	Silber	Tricoat		Anpressdr.	Silber	Tricoat		
				- / + mm				
- / + mm								
Schliessteile fuer G-TS			Bolzenschliesst. U-Profil	Schliessteile fuer G-TS			Bolzenschliessteil ZA	
Anpressdr.	Silber	Tricoat		Anpressdr.	Silber	Tricoat		
				- / + mm				
- / + mm								
Fraesabdeckungen f. Schließteile		Schwarz	Verarbeitungshinweise					
Bolzen								
Haken + Zusatzschloss								
Riegelschliessteil								
HO BO								
Fallen - u. Riegelschliessteil								

Rechtsansprüche aus der Anwendung der in diesem Profilblatt angegebenen Artikel können nicht geltend gemacht werden. Dieses Profilblatt ersetzt keine Pruefung in einem akkreditiertem Pruefinstitut !

SL01T
SLYTEC NEWTEC
 Sly Slytek 67









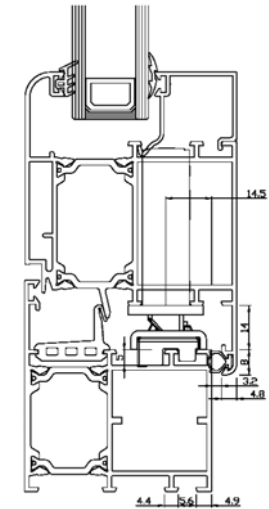



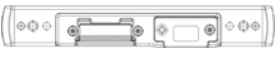
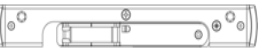

Rahmen

Fluegel

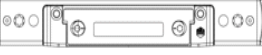
Falzluft mm: Ueberschlag mm: Versatz mm:



Schliessteilleisten U-Profil 													
Schloss	Silber	Tricoat	Silber	Tricoat	Silber	Tricoat	Silber	Tricoat	Silber	Tricoat	Silber	Tricoat	
Fuer Z-TF	2MF + 2iS		2MF + 2iS K+500		2MF + 3iS K+1030		2MF + 4iS		2MF + 4iS K+500		2MF-BO		
rechts													
links													
Fuer Z-TF	2MF-BO K+605		2MF-BO K+980		Fuer Z-TS		2 HO-BO + ZS		4 HO-BO				
rechts					rechts								
links					links								
Fuer Z-TS	3 iS + TB		2 HO-BO + TB		4 iS		3iS + ZS		2 HO-BO		2 HO-BO + 2iS		
rechts													
links													
Fuer G-TS	4 iS		2 BO		2 BO+ZS								
rechts													
links													
Schliessteile fuer Z-TS, Z-TF, G-TS					 i.S. U-Profil			Rechts		Links			
Fallen- u Riegelschliessteile								Silber	Tricoat	Silber	Tricoat		
Ausfuehrung								- / + mm					
		Rechts		Links									
Anpressdr.	Silber	Tricoat	Silber	Tricoat									
Exenter					 i.S. ZA								
f. E-Oeffner													

Schliessteile fuer Z-TF			Fallenschließteil ZT-F		MF-BO f. Z-TF				
Anpressdr.	Silber	Tricoat				Silber	Tricoat		
					rechts				
Excenter					links				
f. E-Oeffner									
Schliessteile fuer Z-TS			TB-Schliessteil		Schliessteile fuer Z-TS			HO-BO ZA	
	Silber	Tricoat			Anpressdr.	Silber	Tricoat		
Rechts						216531			
Links					- / + mm				
Schliessteile fuer Z-TS			HO-BO U		Riegelschliessteil f. 2-flg. Haustueren ZA (Z-TS, Z-TF,G-TS)				
Anpressdr.	Silber	Tricoat			Anpressdr.	Silber	Tricoat		
					- / + mm				
- / + mm									
Schliessteile fuer G-TS			Hakenschliesst. U-Profil		Schliessteile fuer G-TS			Hakenschliessteil ZA	
Anpressdr.	Silber	Tricoat			Anpressdr.	Silber	Tricoat		
					- / + mm				
- / + mm									
Schliessteile fuer G-TS			Bolzenschliesst. U-Profil		Schliessteile fuer G-TS			Bolzenschliessteil ZA	
Anpressdr.	Silber	Tricoat			Anpressdr.	Silber	Tricoat		
					- / + mm				
- / + mm									
Fraesabdeckungen f. Schließteile		Schwarz	Verarbeitungshinweise						
Bolzen									
Haken + Zusatzschloss									
Riegelschliessteil									
HO BO									
Fallen - u. Riegelschliessteil									

Rechtsansprüche aus der Anwendung der in diesem Profilblatt angegebenen Artikel können nicht geltend gemacht werden. Dieses Profilblatt ersetzt keine Pruefung in einem akkreditiertem Pruefinstitut !

HW02T
SPECTUS (HW)
Elite 63_Protect









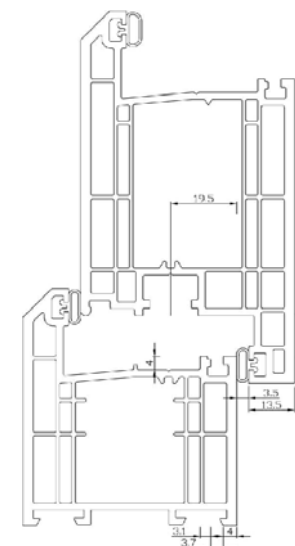



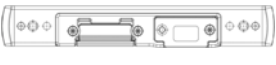
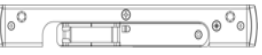

Rahmen

Fluegel

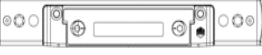
Falzluft mm: Ueberschlag mm: Versatz mm:



Schliessteilleisten U-Profil 														
Schloss	Silber	Tricoat	Silber	Tricoat	Silber	Tricoat	Silber	Tricoat	Silber	Tricoat	Silber	Tricoat		
Fuer Z-TF	2MF + 2iS		2MF + 2iS K+500		2MF + 3iS K+1030		2MF + 4iS		2MF + 4iS K+500		2MF-BO			
rechts														
links														
Fuer Z-TF	2MF-BO K+605		2MF-BO K+980		Fuer Z-TS		2 HO-BO + ZS		4 HO-BO					
rechts					rechts									
links					links									
Fuer Z-TS	3 iS + TB		2 HO-BO + TB		4 iS		3iS + ZS		2 HO-BO		2 HO-BO + 2iS			
rechts														
links														
Fuer G-TS	4 iS		2 BO		2 BO+ZS									
rechts														
links														
Schliessteile fuer Z-TS, Z-TF, G-TS					i.S. U-Profil 					Rechts		Links		
Fallen- u Riegelschliessteile										Silber		Tricoat		Silber
Ausfuehrung		U-6x32x6								- / + mm				
		Rechts		Links										
Anpressdr.	Silber	Tricoat	Silber	Tricoat										
	211053		211054											
Exenter					i.S. ZA 									
f. E-Oeffner														

Schliessteile fuer Z-TF			Fallenschließteil ZT-F	MF-BO f. Z-TF				
Anpressdr.	Silber	Tricoat			Silber	Tricoat		
				rechts				
Excenter				links				
f. E-Oeffner								
Schliessteile fuer Z-TS			TB-Schliessteil	Schliessteile fuer Z-TS			HO-BO ZA	
	Silber	Tricoat		Anpressdr.	Silber	Tricoat		
Rechts								
Links				- / + mm				
Schliessteile fuer Z-TS			HO-BO U	Riegelschliessteil f. 2-flg. Haustueren ZA (Z-TS, Z-TF,G-TS)				
Anpressdr.	Silber	Tricoat		Anpressdr.	Silber	Tricoat		
					212580			
- / + mm				- / + mm				
Schliessteile fuer G-TS			Hakenschliesst. U-Profil	Schliessteile fuer G-TS			Hakenschliessteil ZA	
Anpressdr.	Silber	Tricoat		Anpressdr.	Silber	Tricoat		
					212300			
- / + mm				- / + mm				
Schliessteile fuer G-TS			Bolzenschliesst. U-Profil	Schliessteile fuer G-TS			Bolzenschliessteil ZA	
Anpressdr.	Silber	Tricoat		Anpressdr.	Silber	Tricoat		
- / + mm				- / + mm				
Fraesabdeckungen f. Schließteile		Schwarz	Verarbeitungshinweise					
Bolzen			212300 Hook strike UK silver					
Haken + Zusatzschloss			212580 Dooble slot strike UK silver					
Riegelschliessteil								
HO BO								
Fallen - u. Riegelschliessteil								





Rechtsansprüche aus der Anwendung der in diesem Profilblatt angegebenen Artikel können nicht geltend gemacht werden. Dieses Profilblatt ersetzt keine Pruefung in einem akkreditiertem Pruefinstitut !



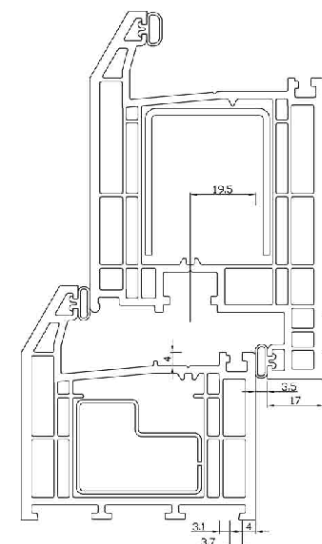





HW03T
SPECTUS (HW)
Elite 70_Protect

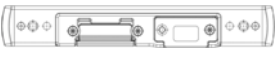
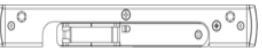

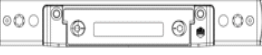
Rahmen	B06, B07;				
Fluegel	B24, B25, B45, B46;				
Falzlufth mm:	12	Ueberschlag mm:	20	Versatz mm:	19.5



Schliessteilleisten U-Profil 												
Schloss	Silber	Tricoat	Silber	Tricoat	Silber	Tricoat	Silber	Tricoat	Silber	Tricoat	Silber	Tricoat
Fuer Z-TF	2MF + 2iS		2MF + 2iS K+500		2MF + 3iS K+1030		2MF + 4iS		2MF + 4iS K+500		2MF-BO	
rechts												
links												
Fuer Z-TF	2MF-BO K+605		2MF-BO K+980		Fuer Z-TS		2 HO-BO + ZS		4 HO-BO			
rechts					rechts							
links					links							
Fuer Z-TS	3 iS + TB		2 HO-BO + TB		4 iS		3iS + ZS		2 HO-BO		2 HO-BO + 2iS	
rechts												
links												
Fuer G-TS	4 iS		2 BO		2 BO+ZS							
rechts												
links												
Schliessteile fuer Z-TS, Z-TF, G-TS					i.S. U-Profil 			Rechts		Links		
Fallen- u Riegelschliessteile								Silber	Tricoat	Silber	Tricoat	
Ausfuehrung		U-6x32x6						- / + mm				
		Rechts		Links								
Anpressdr.	Silber	Tricoat	Silber	Tricoat								
	211053		211054									
i.S. ZA 												
Exenter												
f. E-Oeffner												

Schliessteile fuer Z-TF			Fallenschließteil ZT-F	MF-BO f. Z-TF				
Anpressdr.	Silber	Tricoat			Silber	Tricoat		
				rechts				
Excenter				links				
f. E-Oeffner								
Schliessteile fuer Z-TS			TB-Schliessteil	Schliessteile fuer Z-TS			HO-BO ZA	
	Silber	Tricoat		Anpressdr.	Silber	Tricoat		
Rechts								
Links				- / + mm				
Schliessteile fuer Z-TS			HO-BO U	Riegelschliessteil f. 2-flg. Haustueren ZA (Z-TS, Z-TF,G-TS)				
Anpressdr.	Silber	Tricoat		Anpressdr.	Silber	Tricoat		
					212580			
- / + mm				- / + mm				
Schliessteile fuer G-TS			Hakenschliesst. U-Profil	Schliessteile fuer G-TS			Hakenschliessteil ZA	
Anpressdr.	Silber	Tricoat		Anpressdr.	Silber	Tricoat		
					212300			
- / + mm				- / + mm				
Schliessteile fuer G-TS			Bolzenschliesst. U-Profil	Schliessteile fuer G-TS			Bolzenschliessteil ZA	
Anpressdr.	Silber	Tricoat		Anpressdr.	Silber	Tricoat		
- / + mm				- / + mm				
Fraesabdeckungen f. Schließteile		Schwarz	Verarbeitungshinweise					
Bolzen			212300 Hook strike UK silver					
Haken + Zusatzschloss			212580 Double slot strike UK silver					
Riegelschliessteil								
HO BO								
Fallen - u. Riegelschliessteil								

Rechtsansprüche aus der Anwendung der in diesem Profilblatt angegebenen Artikel können nicht geltend gemacht werden. Dieses Profilblatt ersetzt keine Pruefung in einem akkreditiertem Pruefinstitut !

ST03T
STÖCKEL







Ecostep_Protect



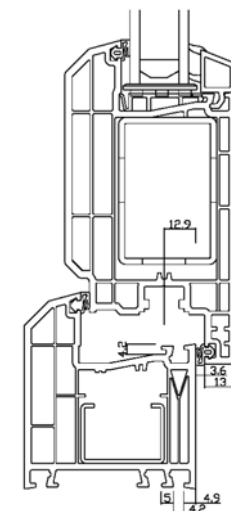



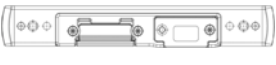
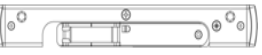

Rahmen

Fluegel

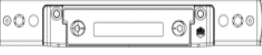
Falzlufth mm: Ueberschlag mm: Versatz mm:



Schliessteilleisten U-Profil 												
Schloss	Silber	Tricoat	Silber	Tricoat	Silber	Tricoat	Silber	Tricoat	Silber	Tricoat	Silber	Tricoat
Fuer Z-TF	2MF + 2iS		2MF + 2iS K+500		2MF + 3iS K+1030		2MF + 4iS		2MF + 4iS K+500		2MF-BO	
rechts	214485		214490		214492							
links	214486		214491		214493							
Fuer Z-TF	2MF-BO K+605		2MF-BO K+980		Fuer Z-TS		2 HO-BO + ZS		4 HO-BO			
rechts					rechts				215690			
links					links				215692			
Fuer Z-TS	3 iS + TB		2 HO-BO + TB		4 iS		3iS + ZS		2 HO-BO		2 HO-BO + 2iS	
rechts					214483				214487			
links					214484				214488			
Fuer G-TS	4 iS		2 BO		2 BO+ZS							
rechts	214483											
links	214484											
Schliessteile fuer Z-TS, Z-TF, G-TS					i.S. U-Profil 			Rechts		Links		
Fallen- u Riegelschliessteile								Silber		Tricoat		Silber
Ausfuehrung		U-6x32x9										
		Rechts		Links								
Anpressdr.	Silber	Tricoat	Silber	Tricoat								
	214495		214496									
Exenter					i.S. ZA 			362936		362937		
f. E-Oeffner												

Schliessteile fuer Z-TF			Fallenschließteil ZT-F	MF-BO f. Z-TF				
Anpressdr.	Silber	Tricoat			Silber	Tricoat		
	214494			rechts				
Excenter				links				
f. E-Oeffner								
Schliessteile fuer Z-TS			TB-Schliessteil	Schliessteile fuer Z-TS			HO-BO ZA	
	Silber	Tricoat		Anpressdr.	Silber	Tricoat		
Rechts	215668				214482			
Links	215669			- / + mm				
Schliessteile fuer Z-TS			HO-BO U	Riegelschliessteil f. 2-flg. Haustueren ZA (Z-TS, Z-TF,G-TS)				
Anpressdr.	Silber	Tricoat		Anpressdr.	Silber	Tricoat		
				- / + mm				
- / + mm								
Schliessteile fuer G-TS			Hakenschliesst. U-Profil	Schliessteile fuer G-TS			Hakenschliessteil ZA	
Anpressdr.	Silber	Tricoat		Anpressdr.	Silber	Tricoat		
				- / + mm				
- / + mm								
Schliessteile fuer G-TS			Bolzenschliesst. U-Profil	Schliessteile fuer G-TS			Bolzenschliessteil ZA	
Anpressdr.	Silber	Tricoat		Anpressdr.	Silber	Tricoat		
				- / + mm				
- / + mm								
Fraesabdeckungen f. Schließteile		Schwarz	Verarbeitungshinweise					
Bolzen								
Haken + Zusatzschloss								
Riegelschliessteil								
HO BO								
Fallen - u. Riegelschliessteil								

Rechtsansprüche aus der Anwendung der in diesem Profilblatt angegebenen Artikel können nicht geltend gemacht werden. Dieses Profilblatt ersetzt keine Pruefung in einem akkreditiertem Pruefinstitut !

SW02T
SWISH



24-7 Door_PROTECT





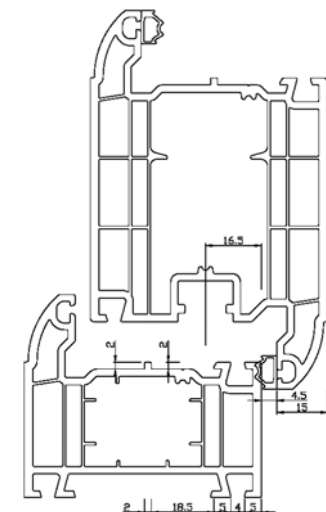

Rahmen

Fluegel

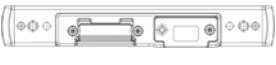
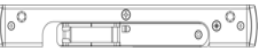
Falzluft mm: Ueberschlag mm: Versatz mm:

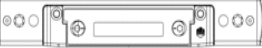

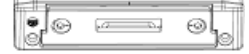
Schliessteilleisten U-Profil														
Schloss	Silber	Tricoat	Silber	Tricoat	Silber	Tricoat	Silber	Tricoat	Silber	Tricoat	Silber	Tricoat		
Fuer Z-TF	2MF + 2iS		2MF + 2iS K+500		2MF + 3iS K+1030		2MF + 4iS		2MF + 4iS K+500		2MF-BO			
rechts														
links														
Fuer Z-TF	2MF-BO K+605		2MF-BO K+980		Fuer Z-TS		2 HO-BO + ZS		4 HO-BO					
rechts					rechts									
links					links									
Fuer Z-TS	3 iS + TB		2 HO-BO + TB		4 iS		3iS + ZS		2 HO-BO		2 HO-BO + 2iS			
rechts														
links														
Fuer G-TS	4 iS		2 BO		2 BO+ZS									
rechts														
links														
Schliessteile fuer Z-TS, Z-TF, G-TS					i.S. U-Profil			Rechts		Links				
Fallen- u Riegelschliessteile								Silber	Tricoat	Silber	Tricoat			
Ausfuehrung														
								- / + mm						
Anpressdr.			Rechts		Links									
			Silber		Tricoat		Silber		Tricoat					
Exenter														
f. E-Oeffner														
							- / + mm							

Schliessteile fuer Z-TF			Fallenschließteil ZT-F			MF-BO f. Z-TF				
Anpressdr.	Silber	Tricoat			Silber	Tricoat				
				rechts						
Excenter				links						
f. E-Oeffner										
Schliessteile fuer Z-TS			TB-Schliessteil			Schliessteile fuer Z-TS			HO-BO ZA	
	Silber	Tricoat		Anpressdr.	Silber	Tricoat				
Rechts										
Links				- / + mm						
Schliessteile fuer Z-TS			HO-BO U			Riegelschliessteil f. 2-flg. Haustueren ZA (Z-TS, Z-TF,G-TS)				
Anpressdr.	Silber	Tricoat		Anpressdr.	Silber	Tricoat				
- / + mm				- / + mm						
Schliessteile fuer G-TS			Hakenschliesst. U-Profil			Schliessteile fuer G-TS			Hakenschliessteil ZA	
Anpressdr.	Silber	Tricoat		Anpressdr.	Silber	Tricoat				
- / + mm				- / + mm						
Schliessteile fuer G-TS			Bolzenschliesst. U-Profil			Schliessteile fuer G-TS			Bolzenschliessteil ZA	
Anpressdr.	Silber	Tricoat		Anpressdr.	Silber	Tricoat				
- / + mm				- / + mm						
Fraesabdeckungen f. Schließteile			Schwarz	Verarbeitungshinweise						
Bolzen										
Haken + Zusatzschloss										
Riegelschliessteil										
HO BO										
Fallen - u. Riegelschliessteil										

Rechtsansprüche aus der Anwendung der in diesem Profilblatt angegebenen Artikel können nicht geltend gemacht werden. Dieses Profilblatt ersetzt keine Pruefung in einem akkreditiertem Pruefinstitut !

SY01T
SYNSEAL













Synerjy_PROTECT

Rahmen

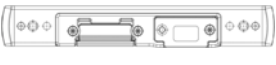
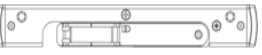
Fluegel

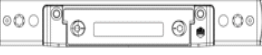
Falzluft mm: Ueberschlag mm: Versatz mm:

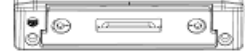
Schliessteilleisten U-Profil 													
Schloss	Silber	Tricoat	Silber	Tricoat	Silber	Tricoat	Silber	Tricoat	Silber	Tricoat	Silber	Tricoat	
Fuer Z-TF	2MF + 2iS		2MF + 2iS K+500		2MF + 3iS K+1030		2MF + 4iS		2MF + 4iS K+500		2MF-BO		
rechts													
links													
Fuer Z-TF	2MF-BO K+605		2MF-BO K+980		Fuer Z-TS		2 HO-BO + ZS		4 HO-BO				
rechts					rechts								
links					links								
Fuer Z-TS	3 iS + TB		2 HO-BO + TB		4 iS		3iS + ZS		2 HO-BO		2 HO-BO + 2iS		
rechts													
links													
Fuer G-TS	4 iS		2 BO		2 BO+ZS								
rechts													
links													
Schliessteile fuer Z-TS, Z-TF, G-TS					 i.S. U-Profil			Rechts		Links			
Fallen- u Riegelschliessteile								Silber	Tricoat	Silber	Tricoat		
Ausfuehrung											- / + mm		
		Rechts		Links									
Anpressdr.	Silber	Tricoat	Silber	Tricoat									
					 i.S. ZA								
Exenter													
f. E-Oeffner													

Schliessteile fuer Z-TF			Fallenschließteil ZT-F	MF-BO f. Z-TF				
Anpressdr.	Silber	Tricoat			Silber	Tricoat		
				rechts				
Excenter				links				
f. E-Oeffner								
Schliessteile fuer Z-TS			TB-Schliessteil	Schliessteile fuer Z-TS			HO-BO ZA	
	Silber	Tricoat		Anpressdr.	Silber	Tricoat		
Rechts								
Links				- / + mm				
Schliessteile fuer Z-TS			HO-BO U	Riegelschliessteil f. 2-flg. Haustueren ZA (Z-TS, Z-TF,G-TS)				
Anpressdr.	Silber	Tricoat		Anpressdr.	Silber	Tricoat		
- / + mm				- / + mm				
Schliessteile fuer G-TS			Hakenschliesst. U-Profil	Schliessteile fuer G-TS			Hakenschliessteil ZA	
Anpressdr.	Silber	Tricoat		Anpressdr.	Silber	Tricoat		
- / + mm				- / + mm				
Schliessteile fuer G-TS			Bolzenschliesst. U-Profil	Schliessteile fuer G-TS			Bolzenschliessteil ZA	
Anpressdr.	Silber	Tricoat		Anpressdr.	Silber	Tricoat		
- / + mm				- / + mm				
Fraesabdeckungen f. Schließteile		Schwarz	Verarbeitungshinweise					
Bolzen								
Haken + Zusatzschloss								
Riegelschliessteil								
HO BO								
Fallen - u. Riegelschliessteil								

Rechtsansprüche aus der Anwendung der in diesem Profilblatt angegebenen Artikel können nicht geltend gemacht werden. Dieses Profilblatt ersetzt keine Pruefung in einem akkreditiertem Pruefinstitut !

TR14T
TROCAL







InnoNova 70.M5_MD_PROTECT



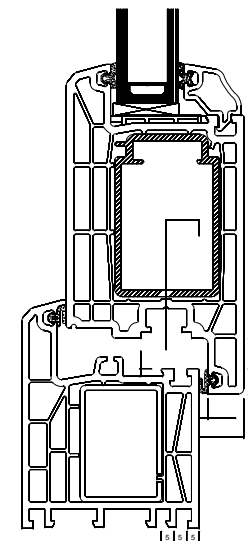



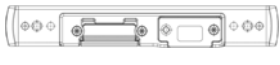
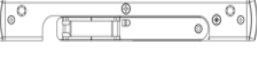

Rahmen

Fluegel

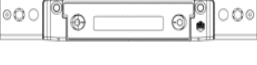
Falzluft mm: Ueberschlag mm: Versatz mm:



Schliessteilleisten U-Profil 												
Schloss	Silber	Tricoat	Silber	Tricoat	Silber	Tricoat	Silber	Tricoat	Silber	Tricoat	Silber	Tricoat
Fuer Z-TF	2MF + 2iS		2MF + 2iS K+500		2MF + 3iS K+1030		2MF + 4iS		2MF + 4iS K+500		2MF-BO	
rechts	213949		213953		213951		213955				216916	
links	213950		213954		213952		213956				216917	
Fuer Z-TF	2MF-BO K+605		2MF-BO K+980		Fuer Z-TS		2 HO-BO + ZS		4 HO-BO			
rechts	216920		216918		rechts							
links	216921		216919		links							
Fuer Z-TS	3 iS + TB		2 HO-BO + TB		4 iS		3iS + ZS		2 HO-BO		2 HO-BO + 2iS	
rechts					208605				213957			
links					208606				213958			
Fuer G-TS	4 iS		2 BO		2 BO+ZS							
rechts	208605											
links	208606											
Schliessteile fuer Z-TS, Z-TF, G-TS					i.S. U-Profil 			Rechts		Links		
Fallen- u Riegelschliessteile								Silber	Tricoat	Silber	Tricoat	
Ausfuehrung	U-6x24x6							- / + mm				
	Rechts		Links									
Anpressdr.	Silber	Tricoat	Silber	Tricoat								
	215200		215205		i.S. ZA 			362196		362197		
Exenter					- / + mm							
f. E-Oeffner	215200		215205									

Schliessteile fuer Z-TF			Fallenschließteil ZT-F		MF-BO f. Z-TF				
Anpressdr.	Silber	Tricoat				Silber	Tricoat		
	215501				rechts	216909			
Excenter					links	216909			
f. E-Oeffner	215501								
Schliessteile fuer Z-TS			TB-Schliessteil		Schliessteile fuer Z-TS			HO-BO ZA	
	Silber	Tricoat			Anpressdr.	Silber	Tricoat		
Rechts						213767			
Links					- / + mm				
Schliessteile fuer Z-TS			HO-BO U		Riegelschliessteil f. 2-flg. Haustueren ZA (Z-TS, Z-TF,G-TS)				
Anpressdr.	Silber	Tricoat			Anpressdr.	Silber	Tricoat		
						213766			
- / + mm					- / + mm				
Schliessteile fuer G-TS			Hakenschliesst. U-Profil		Schliessteile fuer G-TS			Hakenschliessteil ZA	
Anpressdr.	Silber	Tricoat			Anpressdr.	Silber	Tricoat		
						213764			
- / + mm					- / + mm				
Schliessteile fuer G-TS			Bolzenschliesst. U-Profil		Schliessteile fuer G-TS			Bolzenschliessteil ZA	
Anpressdr.	Silber	Tricoat			Anpressdr.	Silber	Tricoat		
						213765			
- / + mm					- / + mm				
Fraesabdeckungen f. Schließteile		Schwarz	Verarbeitungshinweise						
Bolzen		355399	215200, 215205, 215501 f. E-Oeffner eff 118.13A71 Profix2						
Haken + Zusatzschloss		355401	Auslaufende Artikel: Schliessteil f. Falle u. Riegel silber						
Riegelschliessteil		355403	213760 rechts, 213761 links + Fallenschliessteil MF 213762						
HO BO		358027	F. E-Oeffner effeff 118E.15 --- A71 Profix2						
Fallen - u. Riegelschliessteil			213898 rechts, 213899 links, Fallenschliessteil MF: 213900						

Rechtsansprüche aus der Anwendung der in diesem Profilblatt angegebenen Artikel können nicht geltend gemacht werden. Dieses Profilblatt ersetzt keine Pruefung in einem akkreditiertem Pruefinstitut !

TR12T
TROCAL



Innova 2000 MD (70) Stulp 20_PROTECT







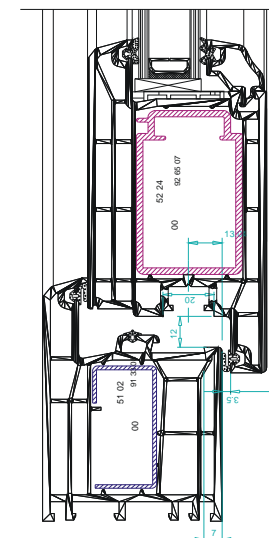

Rahmen

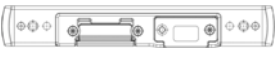
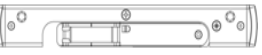
Fluegel

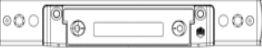
Falzluft mm: Ueberschlag mm: Versatz mm:



Schliessteilleisten U-Profil												
Schloss	Silber	Tricoat	Silber	Tricoat	Silber	Tricoat	Silber	Tricoat	Silber	Tricoat	Silber	Tricoat
Fuer Z-TF	2MF + 2iS		2MF + 2iS K+500		2MF + 3iS K+1030		2MF + 4iS		2MF + 4iS K+500		2MF-BO	
rechts	213937		213941		213939		213943		214642		215898	
links	213938		213942		213940		213944		214643		215899	
Fuer Z-TF	2MF-BO K+605		2MF-BO K+980		Fuer Z-TS		2 HO-BO + ZS		4 HO-BO			
rechts	215902		215900		rechts		214646		213947			
links	215903		215901		links		214647		213948			
Fuer Z-TS	3 iS + TB		2 HO-BO + TB		4 iS		3iS + ZS		2 HO-BO		2 HO-BO + 2iS	
rechts					208607		214644		213945			
links					208608		214645		213946			
Fuer G-TS	4 iS		2 BO		2 BO+ZS							
rechts	208607											
links	208608											
Schliessteile fuer Z-TS, Z-TF, G-TS					i.S. U-Profil			Rechts		Links		
Fallen- u Riegelschliessteile								Silber		Tricoat		Silber
Ausfuehrung					U-6x24x6							
		Rechts		Links								
Anpressdr.	Silber	Tricoat	Silber	Tricoat								
	215195		215207									
Exenter												
f. E-Oeffner	215195		215207		i.S. ZA							
								362176		362176		

Schliessteile fuer Z-TF			Fallenschließteil ZT-F	MF-BO f. Z-TF				
Anpressdr.	Silber	Tricoat			Silber	Tricoat		
	215500			rechts				
Excenter				links				
f. E-Oeffner	215500							
Schliessteile fuer Z-TS			TB-Schliessteil	Schliessteile fuer Z-TS			HO-BO ZA	
	Silber	Tricoat		Anpressdr.	Silber	Tricoat		
Rechts					213190			
Links				- / + mm				
Schliessteile fuer Z-TS			HO-BO U	Riegelschliessteil f. 2-flg. Haustueren ZA (Z-TS, Z-TF,G-TS)				
Anpressdr.	Silber	Tricoat		Anpressdr.	Silber	Tricoat		
				- / + mm				
Schliessteile fuer G-TS			Hakenschliesst. U-Profil	Schliessteile fuer G-TS			Hakenschliessteil ZA	
Anpressdr.	Silber	Tricoat		Anpressdr.	Silber	Tricoat		
				- / + mm				
Schliessteile fuer G-TS			Bolzenschliesst. U-Profil	Schliessteile fuer G-TS			Bolzenschliessteil ZA	
Anpressdr.	Silber	Tricoat		Anpressdr.	Silber	Tricoat		
				- / + mm				
Fraesabdeckungen f. Schließteile		Schwarz	Verarbeitungshinweise					
Bolzen			215195, 215207, 215500 f. E-Oeffner eff 118.13A71 Profix2					
Haken + Zusatzschloss			Auslaufende Artikel: Schliessteil f. Falle u. Riegel silber					
Riegelschliessteil			211166 rechts, 211167 links + Fallenschliessteil MF 211180					
HO BO			F. E-Oeffner effeff 118E.15 --- A71 Profix2					
Fallen - u. Riegelschliessteil			213855 rechts, 213856 links, Fallenschliessteil MF: 213857					

Rechtsansprüche aus der Anwendung der in diesem Profilblatt angegebenen Artikel können nicht geltend gemacht werden. Dieses Profilblatt ersetzt keine Pruefung in einem akkreditiertem Pruefinstitut !

TR11T
TROCAL







InnoNova 70.A5 elegance + classic_PROTECT



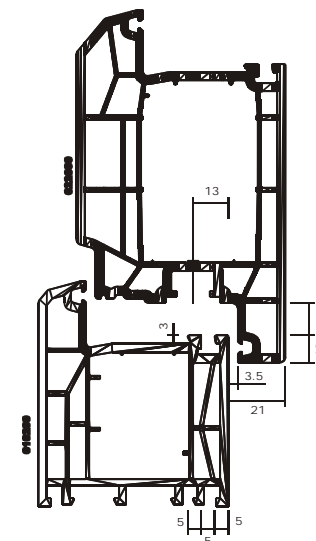



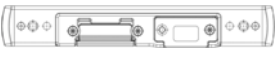
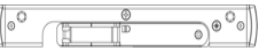

Rahmen

Fluegel

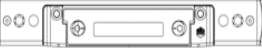
Falzluft mm: Ueberschlag mm: Versatz mm:



Schliessteilleisten U-Profil 												
Schloss	Silber	Tricoat	Silber	Tricoat	Silber	Tricoat	Silber	Tricoat	Silber	Tricoat	Silber	Tricoat
Fuer Z-TF	2MF + 2iS		2MF + 2iS K+500		2MF + 3iS K+1030		2MF + 4iS		2MF + 4iS K+500		2MF-BO	
rechts	210742		213740		213742		213744		213746		216021	
links	210743		213741		213743		213745		213747		216022	
Fuer Z-TF	2MF-BO K+605		2MF-BO K+980		Fuer Z-TS		2 HO-BO + ZS		4 HO-BO			
rechts	216023		216025		rechts				213674			
links	216024		216026		links				213675			
Fuer Z-TS	3 iS + TB		2 HO-BO + TB		4 iS		3iS + ZS		2 HO-BO		2 HO-BO + 2iS	
rechts	214347		214361		208499		208491		208466			
links	214348		214362		208498		208490		208467			
Fuer G-TS	4 iS		2 BO		2 BO+ZS							
rechts	208499		208493		208489							
links	208498		208492		208488							
Schliessteile fuer Z-TS, Z-TF, G-TS					i.S. U-Profil 			Rechts		Links		
Fallen- u Riegelschliessteile								Silber	Tricoat	Silber	Tricoat	
Ausfuehrung	U-6x32x9						207168		207169			
		Rechts		Links								
Anpressdr.	Silber	Tricoat	Silber	Tricoat								
	209184		209185									
Exenter	209181		209182									
f. E-Oeffner												
					i.S. ZA 			354994		355007		
										- / + mm		

Schliessteile fuer Z-TF			Fallenschließteil ZT-F	MF-BO f. Z-TF				
Anpressdr.	Silber	Tricoat			Silber	Tricoat		
	209992			rechts	216027			
Excenter	209183			links	216028			
f. E-Oeffner								
Schliessteile fuer Z-TS			TB-Schliessteil	Schliessteile fuer Z-TS			HO-BO ZA	
	Silber	Tricoat		Anpressdr.	Silber	Tricoat		
Rechts	214375				211556			
Links	214376			- / + mm				
Schliessteile fuer Z-TS			HO-BO U	Riegelschliessteil f. 2-flg. Haustueren ZA (Z-TS, Z-TF,G-TS)				
Anpressdr.	Silber	Tricoat		Anpressdr.	Silber	Tricoat		
					206930			
- / + mm				- / + mm				
Schliessteile fuer G-TS			Hakenschliesst. U-Profil	Schliessteile fuer G-TS			Hakenschliessteil ZA	
Anpressdr.	Silber	Tricoat		Anpressdr.	Silber	Tricoat		
	207166				203545			
- / + mm				- / + mm				
Schliessteile fuer G-TS			Bolzenschliesst. U-Profil	Schliessteile fuer G-TS			Bolzenschliessteil ZA	
Anpressdr.	Silber	Tricoat		Anpressdr.	Silber	Tricoat		
	207167				203558			
- / + mm				- / + mm				
Fraesabdeckungen f. Schließteile		Schwarz	Verarbeitungshinweise					
Bolzen		355399						
Haken + Zusatzschloss		355401						
Riegelschliessteil		355403						
HO BO		358027						
Fallen - u. Riegelschliessteil								

Rechtsansprüche aus der Anwendung der in diesem Profilblatt angegebenen Artikel können nicht geltend gemacht werden. Dieses Profilblatt ersetzt keine Pruefung in einem akkreditiertem Pruefinstitut !





TR10T
TROCAL
Confort_PROTECT









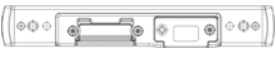
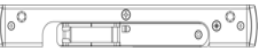

Rahmen

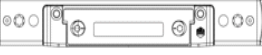
Fluegel

Falzluft mm: Ueberschlag mm: Versatz mm:

Schliessteilleisten U-Profil 												
Schloss	Silber	Tricoat	Silber	Tricoat	Silber	Tricoat	Silber	Tricoat	Silber	Tricoat	Silber	Tricoat
Fuer Z-TF	2MF + 2iS		2MF + 2iS K+500		2MF + 3iS K+1030		2MF + 4iS		2MF + 4iS K+500		2MF-BO	
rechts	210742		213740		213742		213744		213746		216021	
links	210743		213741		213743		213745		213747		216022	
Fuer Z-TF	2MF-BO K+605		2MF-BO K+980		Fuer Z-TS		2 HO-BO + ZS		4 HO-BO			
rechts	216023		216025		rechts				213674			
links	216024		216026		links				213675			
Fuer Z-TS	3 iS + TB		2 HO-BO + TB		4 iS		3iS + ZS		2 HO-BO		2 HO-BO + 2iS	
rechts					208499		208491		208466			
links					208498		208490		208467			
Fuer G-TS	4 iS		2 BO		2 BO+ZS							
rechts	208499		208493		208489							
links	208498		208492		208488							
Schliessteile fuer Z-TS, Z-TF, G-TS					i.S. U-Profil 			Rechts		Links		
Fallen- u Riegelschliessteile								Silber	Tricoat	Silber	Tricoat	
Ausfuehrung	U-6x32x9				207168		207169					
		Rechts		Links		- / + mm						
Anpressdr.	Silber	Tricoat	Silber	Tricoat								
	209184		209185									
Exenter	209181		209182									
f. E-Oeffner												
					i.S. ZA 			354994		355007		
								- / + mm				

Schliessteile fuer Z-TF			Fallenschließteil ZT-F	MF-BO f. Z-TF				
Anpressdr.	Silber	Tricoat			Silber	Tricoat		
	209992			rechts	216027			
Excenter	209183			links	216028			
f. E-Oeffner								
Schliessteile fuer Z-TS			TB-Schliessteil	Schliessteile fuer Z-TS			HO-BO ZA	
	Silber	Tricoat		Anpressdr.	Silber	Tricoat		
Rechts					211556			
Links				- / + mm				
Schliessteile fuer Z-TS			HO-BO U	Riegelschliessteil f. 2-flg. Haustueren ZA (Z-TS, Z-TF,G-TS)				
Anpressdr.	Silber	Tricoat		Anpressdr.	Silber	Tricoat		
					206930			
- / + mm				- / + mm				
Schliessteile fuer G-TS			Hakenschliesst. U-Profil	Schliessteile fuer G-TS			Hakenschliessteil ZA	
Anpressdr.	Silber	Tricoat		Anpressdr.	Silber	Tricoat		
	207166				203545			
- / + mm				- / + mm				
Schliessteile fuer G-TS			Bolzenschliesst. U-Profil	Schliessteile fuer G-TS			Bolzenschliessteil ZA	
Anpressdr.	Silber	Tricoat		Anpressdr.	Silber	Tricoat		
	207167				203558			
- / + mm				- / + mm				
Fraesabdeckungen f. Schließteile		Schwarz	Verarbeitungshinweise					
Bolzen		355399						
Haken + Zusatzschloss		355401						
Riegelschliessteil		355403						
HO BO		358027						
Fallen - u. Riegelschliessteil								

Rechtsansprüche aus der Anwendung der in diesem Profilblatt angegebenen Artikel können nicht geltend gemacht werden. Dieses Profilblatt ersetzt keine Pruefung in einem akkreditiertem Pruefinstitut !

TR16T
TROCAL



System 88+ MD_Protect







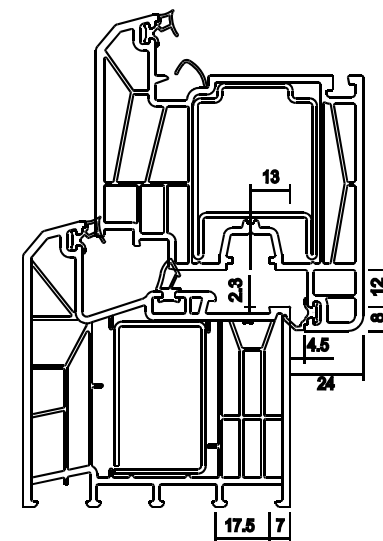

Rahmen

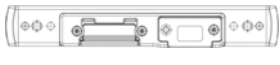
Fluegel

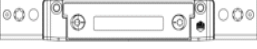
Falzlufth mm: Ueberschlag mm: Versatz mm:



Schliessteilleisten U-Profil													
Schloss	Silber	Tricoat	Silber	Tricoat	Silber	Tricoat	Silber	Tricoat	Silber	Tricoat	Silber	Tricoat	
Fuer Z-TF	2MF + 2iS		2MF + 2iS K+500		2MF + 3iS K+1030		2MF + 4iS		2MF + 4iS K+500		2MF-BO		
rechts	213937		213941		213939		213943		214642		215898		
links	213938		213942		213940		213944		214643		215899		
Fuer Z-TF	2MF-BO K+605		2MF-BO K+980		Fuer Z-TS		2 HO-BO + ZS		4 HO-BO				
rechts	215902		215900		rechts		214646		213947				
links	215903		215901		links		214647		213948				
Fuer Z-TS	3 iS + TB		2 HO-BO + TB		4 iS		3iS + ZS		2 HO-BO		2 HO-BO + 2iS		
rechts					208607		214644		213945				
links					208608		214645		213946				
Fuer G-TS	4 iS		2 BO		2 BO+ZS								
rechts	208607												
links	208608												
Schliessteile fuer Z-TS, Z-TF, G-TS					i.S. U-Profil		Rechts		Links				
Fallen- u Riegelschliessteile							Silber		Tricoat		Silber		Tricoat
Ausfuehrung					U-6x24x6								
		Rechts		Links		- / + mm							
Anpressdr.	Silber	Tricoat	Silber	Tricoat									
	215195		215207										
Exenter													
f. E-Oeffner	215195		215207		i.S. ZA								
							362176		362176				

Schliessteile fuer Z-TF			Fallenschließteil ZT-F	MF-BO f. Z-TF				
Anpressdr.	Silber	Tricoat			Silber	Tricoat		
	215500			rechts				
Excenter				links				
f. E-Oeffner	215500							
Schliessteile fuer Z-TS			TB-Schliessteil	Schliessteile fuer Z-TS			HO-BO ZA	
	Silber	Tricoat		Anpressdr.	Silber	Tricoat		
Rechts					213190			
Links				- / + mm				
Schliessteile fuer Z-TS			HO-BO U	Riegelschliessteil f. 2-flg. Haustueren ZA (Z-TS, Z-TF,G-TS)				
Anpressdr.	Silber	Tricoat		Anpressdr.	Silber	Tricoat		
				- / + mm				
- / + mm								
Schliessteile fuer G-TS			Hakenschliesst. U-Profil	Schliessteile fuer G-TS			Hakenschliessteil ZA	
Anpressdr.	Silber	Tricoat		Anpressdr.	Silber	Tricoat		
				- / + mm				
- / + mm								
Schliessteile fuer G-TS			Bolzenschliesst. U-Profil	Schliessteile fuer G-TS			Bolzenschliessteil ZA	
Anpressdr.	Silber	Tricoat		Anpressdr.	Silber	Tricoat		
				- / + mm				
- / + mm								
Fraesabdeckungen f. Schließteile		Schwarz	Verarbeitungshinweise					
Bolzen			215195, 215207, 215500 f. E-Oeffner eff 118.13A71 Profix2					
Haken + Zusatzschloss			Auslaufende Artikel: Schliessteil f. Falle u. Riegel silber					
Riegelschliessteil			211166 rechts, 211167 links + Fallenschliessteil MF 211180					
HO BO			F. E-Oeffner effeff 118E.15 --- A71 Profix2					
Fallen - u. Riegelschliessteil			213855 rechts, 213856 links, Fallenschliessteil MF: 213857					

Rechtsansprüche aus der Anwendung der in diesem Profilblatt angegebenen Artikel können nicht geltend gemacht werden. Dieses Profilblatt ersetzt keine Pruefung in einem akkreditiertem Pruefinstitut !

VE41T

VEKA

Softline 82 AD U-Stulp









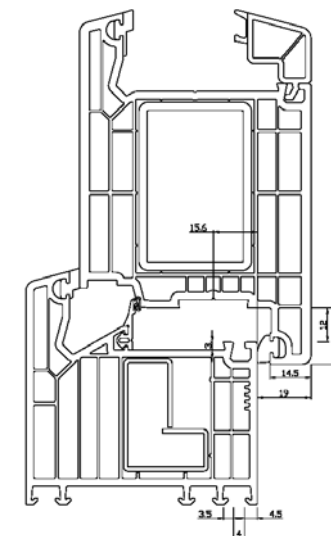



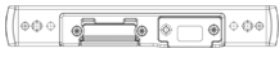
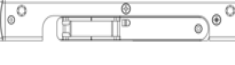

Rahmen

Fluegel

Falzlufth mm: Ueberschlag mm: Versatz mm:



Schliessteilleisten U-Profil 														
Schloss	Silber	Tricoat	Silber	Tricoat	Silber	Tricoat	Silber	Tricoat	Silber	Tricoat	Silber	Tricoat		
Fuer Z-TF	2MF + 2iS		2MF + 2iS K+500		2MF + 3iS K+1030		2MF + 4iS		2MF + 4iS K+500		2MF-BO			
rechts													214150	
links													214151	
Fuer Z-TF	2MF-BO K+605		2MF-BO K+980		Fuer Z-TS		2 HO-BO + ZS		4 HO-BO					
rechts	215268		215270		rechts				215350					
links	215269		215271		links				215351					
Fuer Z-TS	3 iS + TB		2 HO-BO + TB		4 iS		3iS + ZS		2 HO-BO		2 HO-BO + 2iS			
rechts									215348					
links									215349					
Fuer G-TS	4 iS		2 BO		2 BO+ZS									
rechts														
links														
Schliessteile fuer Z-TS, Z-TF, G-TS					i.S. U-Profil 					Rechts		Links		
Fallen- u Riegelschliessteile										Silber		Tricoat		Silber
Ausfuehrung		F-32												
		Rechts		Links										
Anpressdr.	Silber	Tricoat	Silber	Tricoat										
	212461		212462											
i.S. ZA 														
Exenter														
f. E-Oeffner					212461		212462							

Schliessteile fuer Z-TF			Fallenschließteil ZT-F			MF-BO f. Z-TF			
Anpressdr.	Silber	Tricoat			Silber	Tricoat			
				rechts	216458				
				links	216458				
Excenter									
f. E-Oeffner									
Schliessteile fuer Z-TS			TB-Schliessteil			Schliessteile fuer Z-TS			HO-BO ZA
	Silber	Tricoat		Anpressdr.	Silber	Tricoat			
Rechts									
Links				- / + mm					
Schliessteile fuer Z-TS			HO-BO U			Riegelschliessteil f. 2-flg. Haustueren ZA (Z-TS, Z-TF,G-TS)			
Anpressdr.	Silber	Tricoat		Anpressdr.	Silber	Tricoat			
	212463								
- / + mm				- / + mm					
Schliessteile fuer G-TS			Hakenschliesst. U-Profil			Schliessteile fuer G-TS			Hakenschliessteil ZA
Anpressdr.	Silber	Tricoat		Anpressdr.	Silber	Tricoat			
- / + mm				- / + mm					
Schliessteile fuer G-TS			Bolzenschliesst. U-Profil			Schliessteile fuer G-TS			Bolzenschliessteil ZA
Anpressdr.	Silber	Tricoat		Anpressdr.	Silber	Tricoat			
- / + mm				- / + mm					
Fraesabdeckungen f. Schließteile		Schwarz	Verarbeitungshinweise						
Bolzen			f. Fallen+ Riegelschliessteile und MF-BO E-Oeffner:						
Haken + Zusatzschloss			eff-eff 118e.13 Profix 2						
Riegelschliessteil									
HO BO									
Fallen - u. Riegelschliessteil									

Rechtsansprüche aus der Anwendung der in diesem Profilblatt angegebenen Artikel können nicht geltend gemacht werden. Dieses Profilblatt ersetzt keine Pruefung in einem akkreditiertem Pruefinstitut !

VE25T

VEKA

Matrix 70 UK









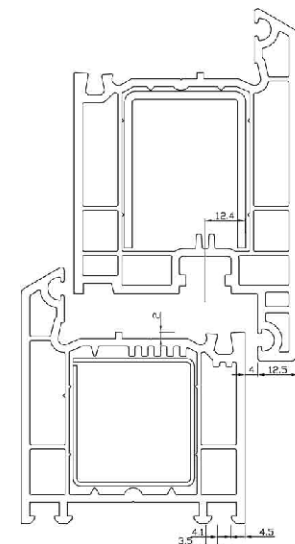



Rahmen 101163, 101147;

Fluegel 105120, 105121, 105126;

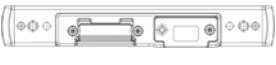
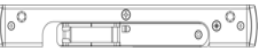



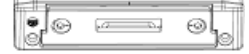



Falzluft mm: 12 Ueberschlag mm: 20 Versatz mm: 13

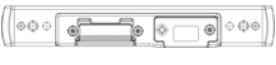
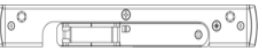

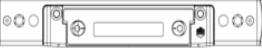
Schliessteilleisten U-Profil 												
Schloss	Silber	Tricoat	Silber	Tricoat	Silber	Tricoat	Silber	Tricoat	Silber	Tricoat	Silber	Tricoat
Fuer Z-TF	2MF + 2iS		2MF + 2iS K+500		2MF + 3iS K+1030		2MF + 4iS		2MF + 4iS K+500		2MF-BO	
rechts												
links												
Fuer Z-TF	2MF-BO K+605		2MF-BO K+980		Fuer Z-TS		2 HO-BO + ZS		4 HO-BO			
rechts					rechts							
links					links							
Fuer Z-TS	3 iS + TB		2 HO-BO + TB		4 iS		3iS + ZS		2 HO-BO		2 HO-BO + 2iS	
rechts												
links												
Fuer G-TS	4 iS		2 BO		2 BO+ZS							
rechts												
links												
Schliessteile fuer Z-TS, Z-TF, G-TS					i.S. U-Profil 			Rechts		Links		
Fallen- u Riegelschliessteile								Silber	Tricoat	Silber	Tricoat	
Ausfuehrung								- / + mm				
		Rechts		Links								
Anpressdr.	Silber	Tricoat	Silber	Tricoat								
					i.S. ZA 							
Exenter								- / + mm				
f. E-Oeffner												

Schliessteile fuer Z-TF			Fallenschließteil ZT-F	MF-BO f. Z-TF				
Anpressdr.	Silber	Tricoat			Silber	Tricoat		
				rechts				
Excenter				links				
f. E-Oeffner								
Schliessteile fuer Z-TS			TB-Schliessteil	Schliessteile fuer Z-TS			HO-BO ZA	
	Silber	Tricoat		Anpressdr.	Silber	Tricoat		
Rechts								
Links				- / + mm				
Schliessteile fuer Z-TS			HO-BO U	Riegelschliessteil f. 2-flg. Haustueren ZA (Z-TS, Z-TF,G-TS)				
Anpressdr.	Silber	Tricoat		Anpressdr.	Silber	Tricoat		
- / + mm				- / + mm				
Schliessteile fuer G-TS			Hakenschliesst. U-Profil	Schliessteile fuer G-TS			Hakenschliessteil ZA	
Anpressdr.	Silber	Tricoat		Anpressdr.	Silber	Tricoat		
- / + mm				- / + mm				
Schliessteile fuer G-TS			Bolzenschliesst. U-Profil	Schliessteile fuer G-TS			Bolzenschliessteil ZA	
Anpressdr.	Silber	Tricoat		Anpressdr.	Silber	Tricoat		
- / + mm				- / + mm				
Fraesabdeckungen f. Schließteile		Schwarz	Verarbeitungshinweise					
Bolzen								
Haken + Zusatzschloss								
Riegelschliessteil								
HO BO								
Fallen - u. Riegelschliessteil								

Rechtsansprüche aus der Anwendung der in diesem Profilblatt angegebenen Artikel können nicht geltend gemacht werden. Dieses Profilblatt ersetzt keine Pruefung in einem akkreditiertem Pruefinstitut !

Schliessteile fuer Z-TF			Fallenschließteil ZT-F	MF-BO f. Z-TF				
Anpressdr.	Silber	Tricoat			Silber	Tricoat		
				rechts				
Excenter				links				
f. E-Oeffner								
Schliessteile fuer Z-TS			TB-Schliessteil	Schliessteile fuer Z-TS			HO-BO ZA	
	Silber	Tricoat		Anpressdr.	Silber	Tricoat		
Rechts								
Links				- / + mm				
Schliessteile fuer Z-TS			HO-BO U	Riegelschliessteil f. 2-flg. Haustueren ZA (Z-TS, Z-TF,G-TS)				
Anpressdr.	Silber	Tricoat		Anpressdr.	Silber	Tricoat		
					212438			
- / + mm				- / + mm				
Schliessteile fuer G-TS			Hakenschliesst. U-Profil	Schliessteile fuer G-TS			Hakenschliessteil ZA	
Anpressdr.	Silber	Tricoat		Anpressdr.	Silber	Tricoat		
	212295							
- / + mm				- / + mm				
Schliessteile fuer G-TS			Bolzenschliesst. U-Profil	Schliessteile fuer G-TS			Bolzenschliessteil ZA	
Anpressdr.	Silber	Tricoat		Anpressdr.	Silber	Tricoat		
- / + mm				- / + mm				
Fraesabdeckungen f. Schließteile		Schwarz	Verarbeitungshinweise					
Bolzen			212295 Hook strike UK silver					
Haken + Zusatzschloss			212438 Double slot strike UK silver					
Riegelschliessteil								
HO BO								
Fallen - u. Riegelschliessteil								

Rechtsansprüche aus der Anwendung der in diesem Profilblatt angegebenen Artikel können nicht geltend gemacht werden. Dieses Profilblatt ersetzt keine Prüfung in einem akkreditiertem Prüfinstitut !

VE21T

VEKA

Softline 70 AD NET Stulp 16mm









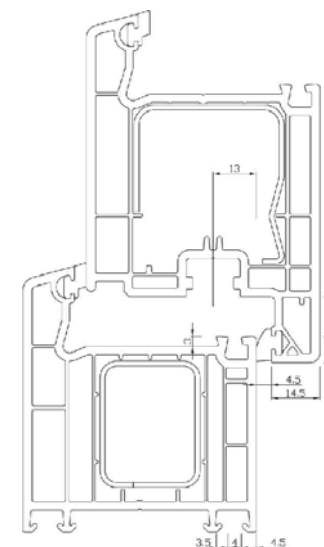



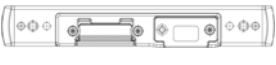

Rahmen

Fluegel

Falzluf t mm: Ueberschlag mm: Versatz mm:

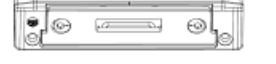

Schliessteilleisten U-Profil 													
Schloss	Silber	Tricoat	Silber	Tricoat	Silber	Tricoat	Silber	Tricoat	Silber	Tricoat	Silber	Tricoat	
Fuer Z-TF	2MF + 2iS		2MF + 2iS K+500		2MF + 3iS K+1030		2MF + 4iS		2MF + 4iS K+500		2MF-BO		
rechts	210732		213685		213687		213629		213689		215583		
links	210733		213686		213688		213630		213690		215584		
Fuer Z-TF	2MF-BO K+605		2MF-BO K+980		Fuer Z-TS		2 HO-BO + ZS		4 HO-BO				
rechts	215585		215587		rechts				213661				
links	215586		215588		links				213662				
Fuer Z-TS	3 iS + TB		2 HO-BO + TB		4 iS		3iS + ZS		2 HO-BO		2 HO-BO + 2iS		
rechts	214339		214353		208586		208580		211636		216459		
links	214340		214354		208585		208579		211637		216460		
Fuer G-TS	4 iS		2 BO		2 BO+ZS								
rechts	208586		208582		208578								
links	208585		208581		208577								
Schliessteile fuer Z-TS, Z-TF, G-TS					i.S. U-Profil 			Rechts		Links			
Fallen- u Riegelschliessteile								Silber	Tricoat	Silber	Tricoat		
Ausfuehrung	U-6x32x9							207160		207161			
		Rechts		Links			- / + mm						
Anpressdr.	Silber	Tricoat	Silber	Tricoat									
	209109		209110										
Exenter	209106		209107										
f. E-Oeffner													
					i.S. ZA 			354988		355001			
								- / + mm					

Schliessteile fuer Z-TF			Fallenschließteil ZT-F	MF-BO f. Z-TF				
Anpressdr.	Silber	Tricoat			Silber	Tricoat		
	209980			rechts	208601			
Excenter	209108			links	208602			
f. E-Oeffner								
Schliessteile fuer Z-TS			TB-Schliessteil	Schliessteile fuer Z-TS			HO-BO ZA	
	Silber	Tricoat		Anpressdr.	Silber	Tricoat		
Rechts	214367				211545			
Links	214368			- / + mm				
Schliessteile fuer Z-TS			HO-BO U	Riegelschliessteil f. 2-flg. Haustueren ZA (Z-TS, Z-TF,G-TS)				
Anpressdr.	Silber	Tricoat		Anpressdr.	Silber	Tricoat		
					206925			
- / + mm				- / + mm				
Schliessteile fuer G-TS			Hakenschliesst. U-Profil	Schliessteile fuer G-TS			Hakenschliessteil ZA	
Anpressdr.	Silber	Tricoat		Anpressdr.	Silber	Tricoat		
	207158				203539			
- / + mm				- / + mm				
Schliessteile fuer G-TS			Bolzenschliesst. U-Profil	Schliessteile fuer G-TS			Bolzenschliessteil ZA	
Anpressdr.	Silber	Tricoat		Anpressdr.	Silber	Tricoat		
	207159				203552			
- / + mm				- / + mm				
Fraesabdeckungen f. Schließteile		Schwarz	Verarbeitungshinweise					
Bolzen		355399						
Haken + Zusatzschloss		355401						
Riegelschliessteil		355403						
HO BO		358027						
Fallen - u. Riegelschliessteil								

Rechtsansprüche aus der Anwendung der in diesem Profilblatt angegebenen Artikel können nicht geltend gemacht werden. Dieses Profilblatt ersetzt keine Pruefung in einem akkreditiertem Pruefinstitut !

VE11T
VEKA



Top-Line AD NET Stulp 16mm







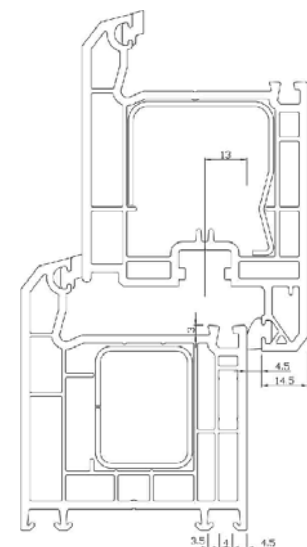

Rahmen 101.200, 101.201, 101.202, 102.201, 102.200, 102.207, 102.208, 111.200

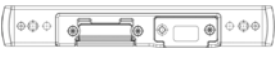
Fluegel 103.200, 103.201, 103.202, 103.204, 103.203

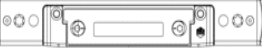
Falzlufth mm: 12 Ueberschlag mm: 20 Versatz mm: 13



Schliessteilleisten U-Profil													
Schloss	Silber	Tricoat	Silber	Tricoat	Silber	Tricoat	Silber	Tricoat	Silber	Tricoat	Silber	Tricoat	
Fuer Z-TF	2MF + 2iS		2MF + 2iS K+500		2MF + 3iS K+1030		2MF + 4iS		2MF + 4iS K+500		2MF-BO		
rechts	210732		213685		213687		213629		213689		215583		
links	210733		213686		213688		213630		213690		215584		
Fuer Z-TF	2MF-BO K+605		2MF-BO K+980		Fuer Z-TS		2 HO-BO + ZS		4 HO-BO				
rechts	215585		215587		rechts				213661				
links	215586		215588		links				213662				
Fuer Z-TS	3 iS + TB		2 HO-BO + TB		4 iS		3iS + ZS		2 HO-BO		2 HO-BO + 2iS		
rechts	214339		214353		208586		208580		211636		216459		
links	214340		214354		208585		208579		211637		216460		
Fuer G-TS	4 iS		2 BO		2 BO+ZS								
rechts	208586		208582		208578								
links	208585		208581		208577								
Schliessteile fuer Z-TS, Z-TF, G-TS					i.S. U-Profil			Rechts		Links			
Fallen- u Riegelschliessteile								Silber	Tricoat	Silber	Tricoat		
Ausfuehrung	U-6x32x9				207160		207161						
		Rechts		Links		- / + mm							
Anpressdr.	Silber	Tricoat	Silber	Tricoat									
	209109		209110										
Exenter	209106		209107										
f. E-Oeffner					i.S. ZA			354988		355001			
						- / + mm							

Schliessteile fuer Z-TF			Fallenschließteil ZT-F	MF-BO f. Z-TF				
Anpressdr.	Silber	Tricoat			Silber	Tricoat		
	209980			rechts	208601			
Excenter	209108			links	208602			
f. E-Oeffner								
Schliessteile fuer Z-TS			TB-Schliessteil	Schliessteile fuer Z-TS			HO-BO ZA	
	Silber	Tricoat		Anpressdr.	Silber	Tricoat		
Rechts	214367				211545			
Links	214368			- / + mm	217617			-2
Schliessteile fuer Z-TS			HO-BO U	Riegelschliessteil f. 2-flg. Haustueren ZA (Z-TS, Z-TF,G-TS)				
Anpressdr.	Silber	Tricoat		Anpressdr.	Silber	Tricoat		
					206925			
- / + mm				- / + mm				
Schliessteile fuer G-TS			Hakenschliesst. U-Profil	Schliessteile fuer G-TS			Hakenschliessteil ZA	
Anpressdr.	Silber	Tricoat		Anpressdr.	Silber	Tricoat		
	207158				203539			
- / + mm				- / + mm				
Schliessteile fuer G-TS			Bolzenschliesst. U-Profil	Schliessteile fuer G-TS			Bolzenschliessteil ZA	
Anpressdr.	Silber	Tricoat		Anpressdr.	Silber	Tricoat		
	207159				203552			
- / + mm				- / + mm				
Fraesabdeckungen f. Schließteile		Schwarz	Verarbeitungshinweise					
Bolzen		355399						
Haken + Zusatzschloss		355401						
Riegelschliessteil		355403						
HO BO		358027						
Fallen - u. Riegelschliessteil								

Rechtsansprüche aus der Anwendung der in diesem Profilblatt angegebenen Artikel können nicht geltend gemacht werden. Dieses Profilblatt ersetzt keine Pruefung in einem akkreditiertem Pruefinstitut !

VE26T

VEKA

Softline 70 AD U-Stulp









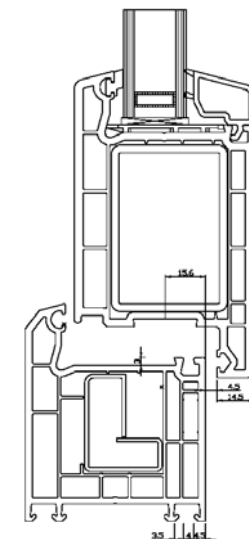



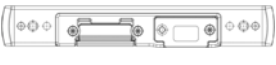
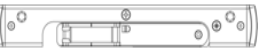

Rahmen

Fluegel

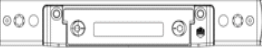
Falzluft mm: Ueberschlag mm: Versatz mm:



Schliessteilleisten U-Profil 													
Schloss	Silber	Tricoat	Silber	Tricoat	Silber	Tricoat	Silber	Tricoat	Silber	Tricoat	Silber	Tricoat	
Fuer Z-TF	2MF + 2iS		2MF + 2iS K+500		2MF + 3iS K+1030		2MF + 4iS		2MF + 4iS K+500		2MF-BO		
rechts												214150	
links												214151	
Fuer Z-TF	2MF-BO K+605		2MF-BO K+980		Fuer Z-TS		2 HO-BO + ZS		4 HO-BO				
rechts	215268		215270		rechts				215350				
links	215269		215271		links				215351				
Fuer Z-TS	3 iS + TB		2 HO-BO + TB		4 iS		3iS + ZS		2 HO-BO		2 HO-BO + 2iS		
rechts									215348				
links									215349				
Fuer G-TS	4 iS		2 BO		2 BO+ZS								
rechts													
links													
Schliessteile fuer Z-TS, Z-TF, G-TS							i.S. U-Profil		Rechts		Links		
Fallen- u Riegelschliessteile				Silber					Tricoat	Silber	Tricoat		
Ausfuehrung		F-32											
		Rechts		Links									
Anpressdr.	Silber	Tricoat	Silber	Tricoat									
	212461		212462										
Exenter													
f. E-Oeffner	212461		212462										
							i.S. ZA						

Schliessteile fuer Z-TF			Fallenschließteil ZT-F	MF-BO f. Z-TF				
Anpressdr.	Silber	Tricoat			Silber	Tricoat		
				rechts	216458			
Excenter				links	216458			
f. E-Oeffner								
Schliessteile fuer Z-TS			TB-Schliessteil	Schliessteile fuer Z-TS			HO-BO ZA	
	Silber	Tricoat		Anpressdr.	Silber	Tricoat		
Rechts								
Links				- / + mm				
Schliessteile fuer Z-TS			HO-BO U	Riegelschliessteil f. 2-flg. Haustueren ZA (Z-TS, Z-TF,G-TS)				
Anpressdr.	Silber	Tricoat		Anpressdr.	Silber	Tricoat		
	212463							
- / + mm				- / + mm				
Schliessteile fuer G-TS			Hakenschliesst. U-Profil	Schliessteile fuer G-TS			Hakenschliessteil ZA	
Anpressdr.	Silber	Tricoat		Anpressdr.	Silber	Tricoat		
- / + mm				- / + mm				
Schliessteile fuer G-TS			Bolzenschliesst. U-Profil	Schliessteile fuer G-TS			Bolzenschliessteil ZA	
Anpressdr.	Silber	Tricoat		Anpressdr.	Silber	Tricoat		
- / + mm				- / + mm				
Fraesabdeckungen f. Schließteile		Schwarz	Verarbeitungshinweise					
Bolzen			f. Fallen+ Riegelschliessteile und MF-BO E-Oeffner:					
Haken + Zusatzschloss			eff-eff 118e.13 Profix 2					
Riegelschliessteil								
HO BO								
Fallen - u. Riegelschliessteil								

Rechtsansprüche aus der Anwendung der in diesem Profilblatt angegebenen Artikel können nicht geltend gemacht werden. Dieses Profilblatt ersetzt keine Pruefung in einem akkreditiertem Pruefinstitut !

VE24T

VEKA

Matrix 70 Sculptured







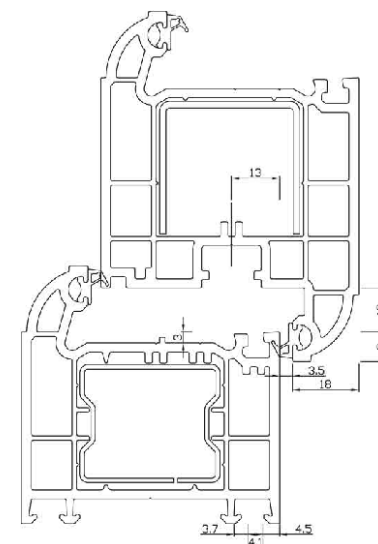

Rahmen 101161, 101162;

Fluegel 103265, 103266;

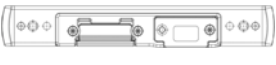
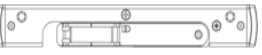
Falzlufth mm: 12 Ueberschlag mm: 20 Versatz mm: 13

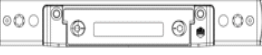

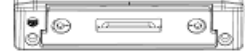
Schliessteilleisten U-Profil												
Schloss	Silber	Tricoat	Silber	Tricoat	Silber	Tricoat	Silber	Tricoat	Silber	Tricoat	Silber	Tricoat
Fuer Z-TF	2MF + 2iS		2MF + 2iS K+500		2MF + 3iS K+1030		2MF + 4iS		2MF + 4iS K+500		2MF-BO	
rechts												
links												
Fuer Z-TF	2MF-BO K+605		2MF-BO K+980		Fuer Z-TS		2 HO-BO + ZS		4 HO-BO			
rechts					rechts							
links					links							
Fuer Z-TS	3 iS + TB		2 HO-BO + TB		4 iS		3iS + ZS		2 HO-BO		2 HO-BO + 2iS	
rechts												
links												
Fuer G-TS	4 iS		2 BO		2 BO+ZS							
rechts												
links												
Schliessteile fuer Z-TS, Z-TF, G-TS					i.S. U-Profil			Rechts		Links		
Fallen- u Riegelschliessteile								Silber	Tricoat	Silber	Tricoat	
Ausfuehrung								- / + mm				
		Rechts		Links								
Anpressdr.	Silber	Tricoat	Silber	Tricoat								
					i.S. ZA							
Exenter								- / + mm				
f. E-Oeffner												

Schliessteile fuer Z-TF			Fallenschließteil ZT-F	MF-BO f. Z-TF				
Anpressdr.	Silber	Tricoat			Silber	Tricoat		
				rechts				
Excenter				links				
f. E-Oeffner								
Schliessteile fuer Z-TS			TB-Schliessteil	Schliessteile fuer Z-TS			HO-BO ZA	
	Silber	Tricoat		Anpressdr.	Silber	Tricoat		
Rechts								
Links				- / + mm				
Schliessteile fuer Z-TS			HO-BO U	Riegelschliessteil f. 2-flg. Haustueren ZA (Z-TS, Z-TF,G-TS)				
Anpressdr.	Silber	Tricoat		Anpressdr.	Silber	Tricoat		
				- / + mm				
- / + mm								
Schliessteile fuer G-TS			Hakenschliesst. U-Profil	Schliessteile fuer G-TS			Hakenschliessteil ZA	
Anpressdr.	Silber	Tricoat		Anpressdr.	Silber	Tricoat		
				- / + mm				
- / + mm								
Schliessteile fuer G-TS			Bolzenschliesst. U-Profil	Schliessteile fuer G-TS			Bolzenschliessteil ZA	
Anpressdr.	Silber	Tricoat		Anpressdr.	Silber	Tricoat		
				- / + mm				
- / + mm								
Fraesabdeckungen f. Schließteile		Schwarz	Verarbeitungshinweise					
Bolzen								
Haken + Zusatzschloss								
Riegelschliessteil								
HO BO								
Fallen - u. Riegelschliessteil								

Rechtsansprüche aus der Anwendung der in diesem Profilblatt angegebenen Artikel können nicht geltend gemacht werden. Dieses Profilblatt ersetzt keine Pruefung in einem akkreditiertem Pruefinstitut !

VE20T

VEKA

Top Line U-Stulp









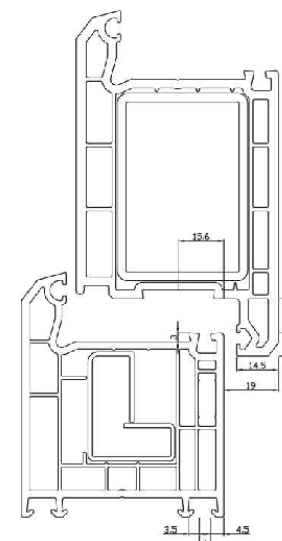



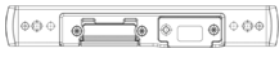
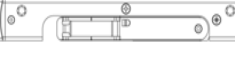

Rahmen

Fluegel

Falzluft mm: Ueberschlag mm: Versatz mm:



Schliessteilleisten U-Profil 												
Schloss	Silber	Tricoat	Silber	Tricoat	Silber	Tricoat	Silber	Tricoat	Silber	Tricoat	Silber	Tricoat
Fuer Z-TF	2MF + 2iS		2MF + 2iS K+500		2MF + 3iS K+1030		2MF + 4iS		2MF + 4iS K+500		2MF-BO	
rechts											214150	
links											214151	
Fuer Z-TF	2MF-BO K+605		2MF-BO K+980		Fuer Z-TS		2 HO-BO + ZS		4 HO-BO			
rechts	215268		215270		rechts				215350			
links	215269		215271		links				215351			
Fuer Z-TS	3 iS + TB		2 HO-BO + TB		4 iS		3iS + ZS		2 HO-BO		2 HO-BO + 2iS	
rechts									215348			
links									215349			
Fuer G-TS	4 iS		2 BO		2 BO+ZS							
rechts												
links												
Schliessteile fuer Z-TS, Z-TF, G-TS					i.S. U-Profil 			Rechts		Links		
Fallen- u Riegelschliessteile								Silber		Tricoat		Silber
Ausfuehrung		F-32										
		Rechts		Links								
Anpressdr.	Silber	Tricoat	Silber	Tricoat								
	212461		212462									
i.S. ZA 												
Exenter												
f. E-Oeffner												

Schliessteile fuer Z-TF			Fallenschließteil ZT-F			MF-BO f. Z-TF			
Anpressdr.	Silber	Tricoat			Silber	Tricoat			
				rechts	216458				
				links	216458				
Excenter									
f. E-Oeffner									
Schliessteile fuer Z-TS			TB-Schliessteil			Schliessteile fuer Z-TS			HO-BO ZA
	Silber	Tricoat		Anpressdr.	Silber	Tricoat			
Rechts									
Links				- / + mm					
Schliessteile fuer Z-TS			HO-BO U			Riegelschliessteil f. 2-flg. Haustueren ZA (Z-TS, Z-TF,G-TS)			
Anpressdr.	Silber	Tricoat		Anpressdr.	Silber	Tricoat			
	212463								
- / + mm				- / + mm					
Schliessteile fuer G-TS			Hakenschliesst. U-Profil			Schliessteile fuer G-TS			Hakenschliessteil ZA
Anpressdr.	Silber	Tricoat		Anpressdr.	Silber	Tricoat			
- / + mm				- / + mm					
Schliessteile fuer G-TS			Bolzenschliesst. U-Profil			Schliessteile fuer G-TS			Bolzenschliessteil ZA
Anpressdr.	Silber	Tricoat		Anpressdr.	Silber	Tricoat			
- / + mm				- / + mm					
Fraesabdeckungen f. Schließteile		Schwarz	Verarbeitungshinweise						
Bolzen			f. Fallen+ Riegelschliessteile und MF-BO E-Oeffner:						
Haken + Zusatzschloss			eff-eff 118e.13 Profix 2						
Riegelschliessteil									
HO BO									
Fallen - u. Riegelschliessteil									

Rechtsansprüche aus der Anwendung der in diesem Profilblatt angegebenen Artikel können nicht geltend gemacht werden. Dieses Profilblatt ersetzt keine Pruefung in einem akkreditiertem Pruefinstitut !

VE17T

VEKA

Kietis_PROTECT









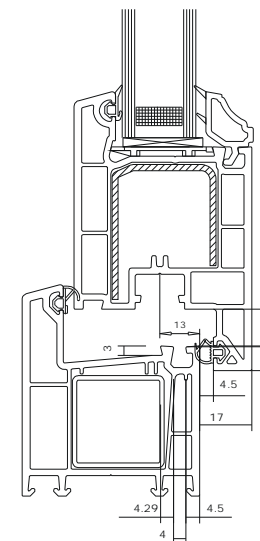



Rahmen

Fluegel

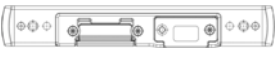
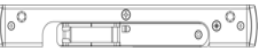
Falzluft mm: Ueberschlag mm: Versatz mm:

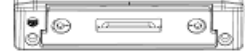

Schliessteilleisten U-Profil 												
Schloss	Silber	Tricoat	Silber	Tricoat	Silber	Tricoat	Silber	Tricoat	Silber	Tricoat	Silber	Tricoat
Fuer Z-TF	2MF + 2iS		2MF + 2iS K+500		2MF + 3iS K+1030		2MF + 4iS		2MF + 4iS K+500		2MF-BO	
rechts												
links												
Fuer Z-TF	2MF-BO K+605		2MF-BO K+980		Fuer Z-TS		2 HO-BO + ZS		4 HO-BO			
rechts					rechts							
links					links							
Fuer Z-TS	3 iS + TB		2 HO-BO + TB		4 iS		3iS + ZS		2 HO-BO		2 HO-BO + 2iS	
rechts												
links												
Fuer G-TS	4 iS		2 BO		2 BO+ZS							
rechts												
links												
Schliessteile fuer Z-TS, Z-TF, G-TS					i.S. U-Profil 			Rechts		Links		
Fallen- u Riegelschliessteile								Silber	Tricoat	Silber	Tricoat	
Ausfuehrung	U-6x32x9					213499		213500				
	Rechts		Links			- / + mm						
Anpressdr.	Silber	Tricoat	Silber	Tricoat								
	213494		213495									
i.S. ZA 					362085		362087					
Exenter					- / + mm							
f. E-Oeffner												

Schliessteile fuer Z-TF			Fallenschließteil ZT-F	MF-BO f. Z-TF				
Anpressdr.	Silber	Tricoat			Silber	Tricoat		
	215237			rechts				
Excenter				links				
f. E-Oeffner	215237							
Schliessteile fuer Z-TS			TB-Schliessteil	Schliessteile fuer Z-TS			HO-BO ZA	
	Silber	Tricoat		Anpressdr.	Silber	Tricoat		
Rechts					215238			
Links				- / + mm				
Schliessteile fuer Z-TS			HO-BO U	Riegelschliessteil f. 2-flg. Haustueren ZA (Z-TS, Z-TF,G-TS)				
Anpressdr.	Silber	Tricoat		Anpressdr.	Silber	Tricoat		
				- / + mm				
- / + mm								
Schliessteile fuer G-TS			Hakenschliesst. U-Profil	Schliessteile fuer G-TS			Hakenschliessteil ZA	
Anpressdr.	Silber	Tricoat		Anpressdr.	Silber	Tricoat		
				- / + mm				
- / + mm								
Schliessteile fuer G-TS			Bolzenschliesst. U-Profil	Schliessteile fuer G-TS			Bolzenschliessteil ZA	
Anpressdr.	Silber	Tricoat		Anpressdr.	Silber	Tricoat		
				- / + mm				
- / + mm								
Fraesabdeckungen f. Schließteile		Schwarz	Verarbeitungshinweise					
Bolzen								
Haken + Zusatzschloss								
Riegelschliessteil								
HO BO								
Fallen - u. Riegelschliessteil								

Rechtsansprüche aus der Anwendung der in diesem Profilblatt angegebenen Artikel können nicht geltend gemacht werden. Dieses Profilblatt ersetzt keine Pruefung in einem akkreditiertem Pruefinstitut !

VE05T

VEKA





Softline AD_PROTECT







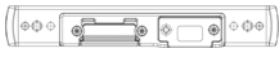
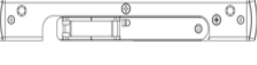

Rahmen 101.085

Fluegel 103.122

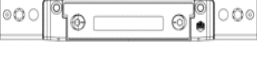
Falzlufth mm: 12 Ueberschlag mm: 20 Versatz mm: 9



Schliessteilleisten U-Profil 												
Schloss	Silber	Tricoat	Silber	Tricoat	Silber	Tricoat	Silber	Tricoat	Silber	Tricoat	Silber	Tricoat
Fuer Z-TF	2MF + 2iS		2MF + 2iS K+500		2MF + 3iS K+1030		2MF + 4iS		2MF + 4iS K+500		2MF-BO	
rechts											215583	
links											215584	
Fuer Z-TF	2MF-BO K+605		2MF-BO K+980		Fuer Z-TS		2 HO-BO + ZS		4 HO-BO			
rechts	215585		215587		rechts							
links	215586		215588		links							
Fuer Z-TS	3 iS + TB		2 HO-BO + TB		4 iS		3iS + ZS		2 HO-BO		2 HO-BO + 2iS	
rechts												
links												
Fuer G-TS	4 iS		2 BO		2 BO+ZS							
rechts												
links												
Schliessteile fuer Z-TS, Z-TF, G-TS					i.S. U-Profil 			Rechts		Links		
Fallen- u Riegelschliessteile								Silber	Tricoat	Silber	Tricoat	
Ausfuehrung	U-6x32x9							- / + mm				
	Rechts		Links									
Anpressdr.	Silber	Tricoat	Silber	Tricoat								
	209189		209190									
Exenter	209186		209187									
f. E-Oeffner						i.S. ZA 		355495		355507		
						- / + mm						

Schliessteile fuer Z-TF			Fallenschließteil ZT-F		MF-BO f. Z-TF				
Anpressdr.	Silber	Tricoat				Silber	Tricoat		
	209993				rechts	208601			
Excenter	209188				links	208602			
f. E-Oeffner									
Schliessteile fuer Z-TS			TB-Schliessteil		Schliessteile fuer Z-TS			HO-BO ZA	
	Silber	Tricoat			Anpressdr.	Silber	Tricoat		
Rechts						211558			
Links					- / + mm				
Schliessteile fuer Z-TS			HO-BO U		Riegelschliessteil f. 2-flg. Haustueren ZA (Z-TS, Z-TF,G-TS)				
Anpressdr.	Silber	Tricoat			Anpressdr.	Silber	Tricoat		
						206924			
- / + mm					- / + mm				
Schliessteile fuer G-TS			Hakenschliesst. U-Profil		Schliessteile fuer G-TS			Hakenschliessteil ZA	
Anpressdr.	Silber	Tricoat			Anpressdr.	Silber	Tricoat		
						204079			
- / + mm					- / + mm				
Schliessteile fuer G-TS			Bolzenschliesst. U-Profil		Schliessteile fuer G-TS			Bolzenschliessteil ZA	
Anpressdr.	Silber	Tricoat			Anpressdr.	Silber	Tricoat		
						204069			
- / + mm					- / + mm				
Fraesabdeckungen f. Schließteile		Schwarz	Verarbeitungshinweise						
Bolzen		355400							
Haken + Zusatzschloss		355402							
Riegelschliessteil		355404							
HO BO		358027							
Fallen - u. Riegelschliessteil									

Rechtsansprüche aus der Anwendung der in diesem Profilblatt angegebenen Artikel können nicht geltend gemacht werden. Dieses Profilblatt ersetzt keine Pruefung in einem akkreditiertem Pruefinstitut !

WH05T

WHS





Halo Rustique







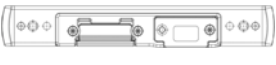
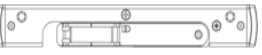

Rahmen

Fluegel

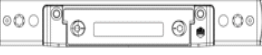
Falzluft mm: Ueberschlag mm: Versatz mm:

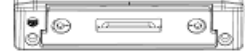
Schliessteilleisten U-Profil 													
Schloss	Silber	Tricoat	Silber	Tricoat	Silber	Tricoat	Silber	Tricoat	Silber	Tricoat	Silber	Tricoat	
Fuer Z-TF	2MF + 2iS		2MF + 2iS K+500		2MF + 3iS K+1030		2MF + 4iS		2MF + 4iS K+500		2MF-BO		
rechts													
links													
Fuer Z-TF	2MF-BO K+605		2MF-BO K+980		Fuer Z-TS		2 HO-BO + ZS		4 HO-BO				
rechts					rechts								
links					links								
Fuer Z-TS	3 iS + TB		2 HO-BO + TB		4 iS		3iS + ZS		2 HO-BO		2 HO-BO + 2iS		
rechts													
links													
Fuer G-TS	4 iS		2 BO		2 BO+ZS								
rechts													
links													
Schliessteile fuer Z-TS, Z-TF, G-TS					 i.S. U-Profil			Rechts		Links			
Fallen- u Riegelschliessteile								Silber	Tricoat	Silber	Tricoat		
Ausfuehrung													
		Rechts		Links				- / + mm					
Anpressdr.	Silber	Tricoat	Silber	Tricoat									
					 i.S. ZA								
Exenter								- / + mm					
f. E-Oeffner													

Schliessteile fuer Z-TF			Fallenschließteil ZT-F	MF-BO f. Z-TF				
Anpressdr.	Silber	Tricoat			Silber	Tricoat		
				rechts				
Excenter				links				
f. E-Oeffner								
Schliessteile fuer Z-TS			TB-Schliessteil	Schliessteile fuer Z-TS			HO-BO ZA	
	Silber	Tricoat		Anpressdr.	Silber	Tricoat		
Rechts								
Links				- / + mm				
Schliessteile fuer Z-TS			HO-BO U	Riegelschliessteil f. 2-flg. Haustueren ZA (Z-TS, Z-TF,G-TS)				
Anpressdr.	Silber	Tricoat		Anpressdr.	Silber	Tricoat		
- / + mm				- / + mm				
Schliessteile fuer G-TS			Hakenschliesst. U-Profil	Schliessteile fuer G-TS			Hakenschliessteil ZA	
Anpressdr.	Silber	Tricoat		Anpressdr.	Silber	Tricoat		
- / + mm				- / + mm				
Schliessteile fuer G-TS			Bolzenschliesst. U-Profil	Schliessteile fuer G-TS			Bolzenschliessteil ZA	
Anpressdr.	Silber	Tricoat		Anpressdr.	Silber	Tricoat		
- / + mm				- / + mm				
Fraesabdeckungen f. Schließteile		Schwarz	Verarbeitungshinweise					
Bolzen								
Haken + Zusatzschloss								
Riegelschliessteil								
HO BO								
Fallen - u. Riegelschliessteil								

Rechtsansprüche aus der Anwendung der in diesem Profilblatt angegebenen Artikel können nicht geltend gemacht werden. Dieses Profilblatt ersetzt keine Pruefung in einem akkreditiertem Pruefinstitut !

WH04T

WHS





Halo Eclipse









Rahmen

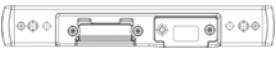
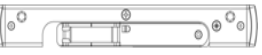



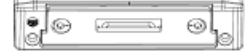

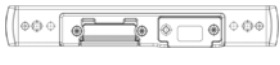
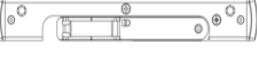

Fluegel

Falzluft mm: Ueberschlag mm: Versatz mm:

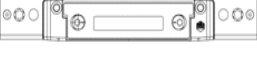
Schliessteilleisten U-Profil 													
Schloss	Silber	Tricoat	Silber	Tricoat	Silber	Tricoat	Silber	Tricoat	Silber	Tricoat	Silber	Tricoat	
Fuer Z-TF	2MF + 2iS		2MF + 2iS K+500		2MF + 3iS K+1030		2MF + 4iS		2MF + 4iS K+500		2MF-BO		
rechts													
links													
Fuer Z-TF	2MF-BO K+605		2MF-BO K+980		Fuer Z-TS		2 HO-BO + ZS		4 HO-BO				
rechts					rechts								
links					links								
Fuer Z-TS	3 iS + TB		2 HO-BO + TB		4 iS		3iS + ZS		2 HO-BO		2 HO-BO + 2iS		
rechts													
links													
Fuer G-TS	4 iS		2 BO		2 BO+ZS								
rechts													
links													
Schliessteile fuer Z-TS, Z-TF, G-TS					 i.S. U-Profil			Rechts		Links			
Fallen- u Riegelschliessteile								Silber	Tricoat	Silber	Tricoat		
Ausfuehrung													
		Rechts		Links									
Anpressdr.	Silber	Tricoat	Silber	Tricoat									
					 i.S. ZA								
Exenter													
f. E-Oeffner													

Schliessteile fuer Z-TF			Fallenschließteil ZT-F	MF-BO f. Z-TF				
Anpressdr.	Silber	Tricoat			Silber	Tricoat		
				rechts				
Excenter				links				
f. E-Oeffner								
Schliessteile fuer Z-TS			TB-Schliessteil	Schliessteile fuer Z-TS			HO-BO ZA	
	Silber	Tricoat		Anpressdr.	Silber	Tricoat		
Rechts								
Links				- / + mm				
Schliessteile fuer Z-TS			HO-BO U	Riegelschliessteil f. 2-flg. Haustueren ZA (Z-TS, Z-TF,G-TS)				
Anpressdr.	Silber	Tricoat		Anpressdr.	Silber	Tricoat		
- / + mm				- / + mm				
Schliessteile fuer G-TS			Hakenschliesst. U-Profil	Schliessteile fuer G-TS			Hakenschliessteil ZA	
Anpressdr.	Silber	Tricoat		Anpressdr.	Silber	Tricoat		
- / + mm				- / + mm				
Schliessteile fuer G-TS			Bolzenschliesst. U-Profil	Schliessteile fuer G-TS			Bolzenschliessteil ZA	
Anpressdr.	Silber	Tricoat		Anpressdr.	Silber	Tricoat		
- / + mm				- / + mm				
Fraesabdeckungen f. Schließteile		Schwarz	Verarbeitungshinweise					
Bolzen								
Haken + Zusatzschloss								
Riegelschliessteil								
HO BO								
Fallen - u. Riegelschliessteil								

Rechtsansprüche aus der Anwendung der in diesem Profilblatt angegebenen Artikel können nicht geltend gemacht werden. Dieses Profilblatt ersetzt keine Pruefung in einem akkreditiertem Pruefinstitut !

Schliessteile fuer Z-TF			Fallenschließteil ZT-F		MF-BO f. Z-TF				
Anpressdr.	Silber	Tricoat				Silber	Tricoat		
	209994				rechts				
Excenter	209193				links				
f. E-Oeffner									
Schliessteile fuer Z-TS			TB-Schliessteil		Schliessteile fuer Z-TS			HO-BO ZA	
	Silber	Tricoat			Anpressdr.	Silber	Tricoat		
Rechts						211561			
Links					- / + mm	217613			-2
Schliessteile fuer Z-TS			HO-BO U		Riegelschliessteil f. 2-flg. Haustueren ZA (Z-TS, Z-TF,G-TS)				
Anpressdr.	Silber	Tricoat			Anpressdr.	Silber	Tricoat		
						206939			
- / + mm					- / + mm				
Schliessteile fuer G-TS			Hakenschliesst. U-Profil		Schliessteile fuer G-TS			Hakenschliessteil ZA	
Anpressdr.	Silber	Tricoat			Anpressdr.	Silber	Tricoat		
						206906			
- / + mm					- / + mm				
Schliessteile fuer G-TS			Bolzenschliesst. U-Profil		Schliessteile fuer G-TS			Bolzenschliessteil ZA	
Anpressdr.	Silber	Tricoat			Anpressdr.	Silber	Tricoat		
						206915			
- / + mm					- / + mm	211843			-2
Fraesabdeckungen f. Schließteile		Schwarz	Verarbeitungshinweise						
Bolzen		355399							
Haken + Zusatzschloss		355401							
Riegelschliessteil		355403							
HO BO		358027							
Fallen - u. Riegelschliessteil									

Rechtsansprüche aus der Anwendung der in diesem Profilblatt angegebenen Artikel können nicht geltend gemacht werden. Dieses Profilblatt ersetzt keine Pruefung in einem akkreditiertem Pruefinstitut !

WY08T

WYMAR



3000 AD aussen drehend_PROTECT







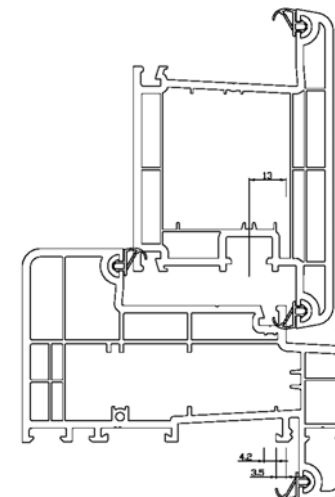

Rahmen 3082,3080,3090;

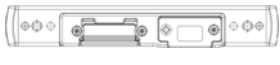
Fluegel 3204;

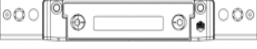
Falzluft mm: 12 Ueberschlag mm: 20 Versatz mm: 13



Schliessteilleisten U-Profil												
Schloss	Silber	Tricoat	Silber	Tricoat	Silber	Tricoat	Silber	Tricoat	Silber	Tricoat	Silber	Tricoat
Fuer Z-TF	2MF + 2iS		2MF + 2iS K+500		2MF + 3iS K+1030		2MF + 4iS		2MF + 4iS K+500		2MF-BO	
rechts	217226		217228		217230		217232		217234		217236	
links	217227		217229		217231		217233		217235		217237	
Fuer Z-TF	2MF-BO K+605		2MF-BO K+980		Fuer Z-TS		2 HO-BO + ZS		4 HO-BO			
rechts	217238		217240		rechts							
links	217239		217241		links							
Fuer Z-TS	3 iS + TB		2 HO-BO + TB		4 iS		3iS + ZS		2 HO-BO		2 HO-BO + 2iS	
rechts					215979							
links					215980							
Fuer G-TS	4 iS		2 BO		2 BO+ZS							
rechts	215979											
links	215980											
Schliessteile fuer Z-TS, Z-TF, G-TS					i.S. U-Profil			Rechts		Links		
Fallen- u Riegelschliessteile								Silber		Tricoat		Silber
Ausfuehrung					U-6x32x9							
		Rechts		Links								
Anpressdr.	Silber	Tricoat	Silber	Tricoat								
	210281		210280									
Exenter	215975		215976									
f. E-Oeffner	210281		210280									
					i.S. ZA			363395		363396		

Schliessteile fuer Z-TF			Fallenschließteil ZT-F	MF-BO f. Z-TF				
Anpressdr.	Silber	Tricoat			Silber	Tricoat		
	2159977			rechts				
Excenter				links				
f. E-Oeffner	215977							
Schliessteile fuer Z-TS			TB-Schliessteil	Schliessteile fuer Z-TS			HO-BO ZA	
	Silber	Tricoat		Anpressdr.	Silber	Tricoat		
Rechts					211563			
Links				- / + mm				
Schliessteile fuer Z-TS			HO-BO U	Riegelschliessteil f. 2-flg. Haustueren ZA (Z-TS, Z-TF,G-TS)				
Anpressdr.	Silber	Tricoat		Anpressdr.	Silber	Tricoat		
					216052			
- / + mm				- / + mm				
Schliessteile fuer G-TS			Hakenschliesst. U-Profil	Schliessteile fuer G-TS			Hakenschliessteil ZA	
Anpressdr.	Silber	Tricoat		Anpressdr.	Silber	Tricoat		
				- / + mm				
- / + mm								
Schliessteile fuer G-TS			Bolzenschliesst. U-Profil	Schliessteile fuer G-TS			Bolzenschliessteil ZA	
Anpressdr.	Silber	Tricoat		Anpressdr.	Silber	Tricoat		
				- / + mm				
- / + mm								
Fraesabdeckungen f. Schließteile		Schwarz	Verarbeitungshinweise					
Bolzen								
Haken + Zusatzschloss								
Riegelschliessteil								
HO BO								
Fallen - u. Riegelschliessteil								

Rechtsansprüche aus der Anwendung der in diesem Profilblatt angegebenen Artikel können nicht geltend gemacht werden. Dieses Profilblatt ersetzt keine Pruefung in einem akkreditiertem Pruefinstitut !

WY07T
WYMAR



Profex Reponse_PROTECT

Rahmen

Fluegel

Falzluft mm: Ueberschlag mm: Versatz mm:



Rahmen





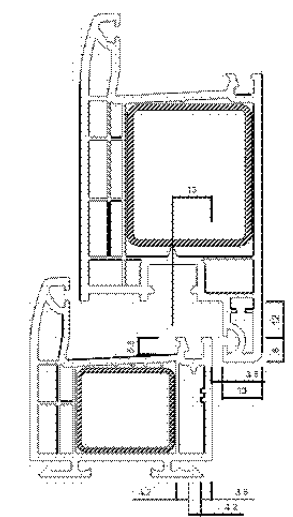

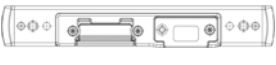

Fluegel

Falzschiesseteil U2 Profil Ueberschlag mm: Versatz mm:

Schloss	Silber	Tricoat	Silber	Tricoat	Silber	Tricoat	Silber	Tricoat	Silber	Tricoat	Silber	Tricoat
Fuer Z-TF	2MF + 2iS		2MF + 2iS K+500		2MF + 3iS K+1030		2MF + 4iS		2MF + 4iS K+500		2MF-BO	
rechts												
links												
Fuer Z-TF	2MF-BO K+605		2MF-BO K+980		Fuer Z-TS		2 HO-BO + ZS		4 HO-BO			
rechts					rechts							
links					links							
Fuer Z-TS	3 iS + TB		2 HO-BO + TB		4 iS		3iS + ZS		2 HO-BO		2 HO-BO + 2iS	
rechts												
links												
Fuer G-TS	4 iS		2 BO		2 BO+ZS							
rechts												
links												

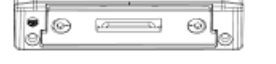

Schliessteile fuer Z-TS, Z-TF, G-TS					i.S. U-Profil	Rechts		Links	
Fallen- u Riegelschliessteile						Silber	Tricoat	Silber	Tricoat
Ausfuehrung	U-6x32x6					213273		213274	
	Rechts		Links			- / + mm			
Anpressdr.	Silber	Tricoat	Silber	Tricoat					
	213270		213271						
Exenter									
f. E-Oeffner									
					i.S. ZA	361842		361843	
						- / + mm			

Schliessteile fuer Z-TF			Fallenschließteil ZT-F			MF-BO f. Z-TF				
Anpressdr.	Silber	Tricoat			Silber	Tricoat				
	213272			rechts						
Excenter				links						
f. E-Oeffner										
Schliessteile fuer Z-TS			TB-Schliessteil			Schliessteile fuer Z-TS			HO-BO ZA	
	Silber	Tricoat		Anpressdr.	Silber	Tricoat				
Rechts					213279					
Links				- / + mm						
Schliessteile fuer Z-TS			HO-BO U			Riegelschliessteil f. 2-flg. Haustueren ZA (Z-TS, Z-TF,G-TS)				
Anpressdr.	Silber	Tricoat		Anpressdr.	Silber	Tricoat				
				- / + mm						
Schliessteile fuer G-TS			Hakenschliesst. U-Profil			Schliessteile fuer G-TS			Hakenschliessteil ZA	
Anpressdr.	Silber	Tricoat		Anpressdr.	Silber	Tricoat				
	213276			- / + mm		213275				
Schliessteile fuer G-TS			Bolzenschliesst. U-Profil			Schliessteile fuer G-TS			Bolzenschliessteil ZA	
Anpressdr.	Silber	Tricoat		Anpressdr.	Silber	Tricoat				
	213278			- / + mm		213277				
Fraesabdeckungen f. Schließteile			Schwarz	Verarbeitungshinweise						
Bolzen										
Haken + Zusatzschloss										
Riegelschliessteil										
HO BO										
Fallen - u. Riegelschliessteil										

Rechtsansprüche aus der Anwendung der in diesem Profilblatt angegebenen Artikel können nicht geltend gemacht werden. Dieses Profilblatt ersetzt keine Pruefung in einem akkreditiertem Pruefinstitut !

WY05T

WYMAR

3000 AD_PROTECT









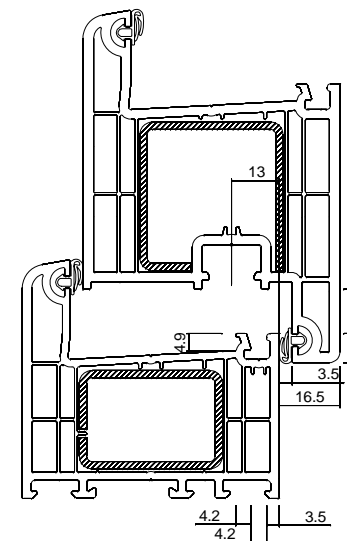



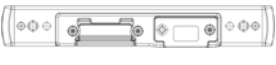

Rahmen 3001

Fluegel 3203

Falzluft mm: 12 Ueberschlag mm: 20 Versatz mm: 13

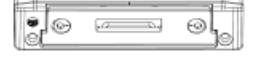

Schliessteilleisten U-Profil 												
Schloss	Silber	Tricoat	Silber	Tricoat	Silber	Tricoat	Silber	Tricoat	Silber	Tricoat	Silber	Tricoat
Fuer Z-TF	2MF + 2iS		2MF + 2iS K+500		2MF + 3iS K+1030		2MF + 4iS		2MF + 4iS K+500		2MF-BO	
rechts	210917		214528		214530		214532		214534		216300	
links	210918		214529		214531		214533		214535		216301	
Fuer Z-TF	2MF-BO K+605		2MF-BO K+980		Fuer Z-TS		2 HO-BO + ZS		4 HO-BO			
rechts	216302		216304		rechts							
links	216303		216305		links							
Fuer Z-TS	3 iS + TB		2 HO-BO + TB		4 iS		3iS + ZS		2 HO-BO		2 HO-BO + 2iS	
rechts					213598		213600					
links					213599		213602					
Fuer G-TS	4 iS		2 BO		2 BO+ZS							
rechts	213598											
links	213599											
Schliessteile fuer Z-TS, Z-TF, G-TS					i.S. U-Profil 			Rechts		Links		
Fallen- u Riegelschliessteile								Silber	Tricoat	Silber	Tricoat	
Ausfuehrung	U-6x32x9							- / + mm				
	Rechts		Links									
Anpressdr.	Silber	Tricoat	Silber	Tricoat								
	209199		209200			357373			357374			
Exenter	209196		209197			- / + mm						
f. E-Oeffner						362144		362145				-1

Schliessteile fuer Z-TF			Fallenschließteil ZT-F	MF-BO f. Z-TF				
Anpressdr.	Silber	Tricoat			Silber	Tricoat		
	209995			rechts	216306			
Excenter	209198			links	216307			
f. E-Oeffner								
Schliessteile fuer Z-TS			TB-Schliessteil	Schliessteile fuer Z-TS			HO-BO ZA	
	Silber	Tricoat		Anpressdr.	Silber	Tricoat		
Rechts					211562			
Links				- / + mm	216011			-2.5
Schliessteile fuer Z-TS			HO-BO U	Riegelschliessteil f. 2-flg. Haustueren ZA (Z-TS, Z-TF,G-TS)				
Anpressdr.	Silber	Tricoat		Anpressdr.	Silber	Tricoat		
					206940			
- / + mm				- / + mm				
Schliessteile fuer G-TS			Hakenschliesst. U-Profil	Schliessteile fuer G-TS			Hakenschliessteil ZA	
Anpressdr.	Silber	Tricoat		Anpressdr.	Silber	Tricoat		
					206907			
- / + mm				- / + mm				
Schliessteile fuer G-TS			Bolzenschliesst. U-Profil	Schliessteile fuer G-TS			Bolzenschliessteil ZA	
Anpressdr.	Silber	Tricoat		Anpressdr.	Silber	Tricoat		
					206916			
- / + mm				- / + mm	212347			-2.4
Fraesabdeckungen f. Schließteile		Schwarz	Verarbeitungshinweise					
Bolzen		355399	Hook Strike -1mm APD niedrigere Bauhöhe 217606					
Haken + Zusatzschloss		355401	HO-BO Za -2mm APD 217614					
Riegelschliessteil		355403						
HO BO		358027						
Fallen - u. Riegelschliessteil								

Rechtsansprüche aus der Anwendung der in diesem Profilblatt angegebenen Artikel können nicht geltend gemacht werden. Dieses Profilblatt ersetzt keine Pruefung in einem akkreditiertem Pruefinstitut !

WY09T

WYMAR

3000 AD aussen drehend BLR 3083_PROTECT









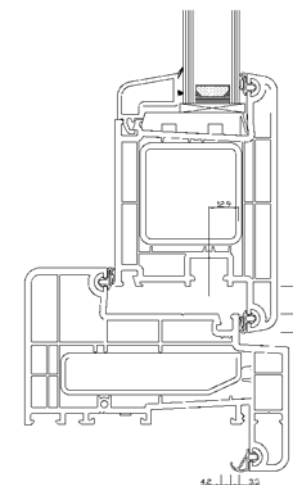

Rahmen 3083, 3085;3080,3090 + Zusatzprofil 3081

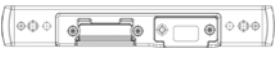
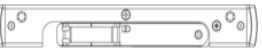
Fluegel 3204;

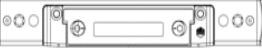
Falzlufth mm: 12 Ueberschlag mm: 20 Versatz mm: 13



Schliessteilleisten U-Profil													
Schloss	Silber	Tricoat	Silber	Tricoat	Silber	Tricoat	Silber	Tricoat	Silber	Tricoat	Silber	Tricoat	
Fuer Z-TF	2MF + 2iS		2MF + 2iS K+500		2MF + 3iS K+1030		2MF + 4iS		2MF + 4iS K+500		2MF-BO		
rechts													
links													
Fuer Z-TF	2MF-BO K+605		2MF-BO K+980		Fuer Z-TS		2 HO-BO + ZS		4 HO-BO				
rechts					rechts								
links					links								
Fuer Z-TS	3 iS + TB		2 HO-BO + TB		4 iS		3iS + ZS		2 HO-BO		2 HO-BO + 2iS		
rechts					215979								
links					215980								
Fuer G-TS	4 iS		2 BO		2 BO+ZS								
rechts	215979												
links	215980												
Schliessteile fuer Z-TS, Z-TF, G-TS					i.S. U-Profil			Rechts		Links			
Fallen- u Riegelschliessteile								Silber	Tricoat	Silber	Tricoat		
Ausfuehrung	U-6x32x6							- / + mm					
	Rechts		Links										
Anpressdr.	Silber	Tricoat	Silber	Tricoat									
	210281		210280										
Exenter	215975		215976										
f. E-Oeffner													
					i.S. ZA			363395		363396			
								- / + mm					

Schliessteile fuer Z-TF			Fallenschließteil ZT-F		MF-BO f. Z-TF				
Anpressdr.	Silber	Tricoat				Silber	Tricoat		
	215977				rechts				
Excenter					links				
f. E-Oeffner									
Schliessteile fuer Z-TS			TB-Schliessteil		Schliessteile fuer Z-TS			HO-BO ZA	
	Silber	Tricoat			Anpressdr.	Silber	Tricoat		
Rechts						211563			
Links					- / + mm				
Schliessteile fuer Z-TS			HO-BO U		Riegelschliessteil f. 2-flg. Haustueren ZA (Z-TS, Z-TF,G-TS)				
Anpressdr.	Silber	Tricoat			Anpressdr.	Silber	Tricoat		
						216052			
- / + mm					- / + mm				
Schliessteile fuer G-TS			Hakenschliesst. U-Profil		Schliessteile fuer G-TS			Hakenschliessteil ZA	
Anpressdr.	Silber	Tricoat			Anpressdr.	Silber	Tricoat		
					- / + mm				
- / + mm									
Schliessteile fuer G-TS			Bolzenschliesst. U-Profil		Schliessteile fuer G-TS			Bolzenschliessteil ZA	
Anpressdr.	Silber	Tricoat			Anpressdr.	Silber	Tricoat		
					- / + mm				
- / + mm									
Fraesabdeckungen f. Schließteile		Schwarz	Verarbeitungshinweise						
Bolzen									
Haken + Zusatzschloss									
Riegelschliessteil									
HO BO									
Fallen - u. Riegelschliessteil									

Rechtsansprüche aus der Anwendung der in diesem Profilblatt angegebenen Artikel können nicht geltend gemacht werden. Dieses Profilblatt ersetzt keine Pruefung in einem akkreditiertem Pruefinstitut !